

J. Tomków*, D. Fydrych, G. Rogalski, J. Łabanowski

Gdansk University of Technology, Faculty of Mechanical Engineering, Department of Materials Science and Welding Engineering, 11/12 Narutowicza, 80-233 Gdańsk, Poland

* jacek.tomkow@pg.edu.pl

TEMPER BEAD WELDING OF S460N STEEL IN WET WELDING CONDITIONS

ABSTRACT

Wet welding is the most common method of welding in water environment. It is most often used for repairing of underwater parts of offshore structures. However, the water as a welding environment causes an increase of susceptibility of steels to cold cracking. For underwater constructions high strength low alloy (HSLA) steel are widely used. In wet welding condition a HSLA steel is characterized by high susceptibility to cold cracking. Temper Bead Welding (TBW) was chosen as a method to improve the weldability of S460N steel. The studies showed that TBW technique causes significant decrease of maximum hardness of heat affected zone (HAZ). The largest decrease in hardness occurred in specimens with the pitches in range 66-100%.

Keywords: temper bead welding, underwater welding, covered electrodes, weldability, cold cracking

INTRODUCTION

Each year, high strength low alloy (HSLA) steels are used much more in: construction [1], automotive [2] and offshore structures [3]. Application of HSLA steels brings benefits in the form of reduction of thickness and weight of elements, reduction of welding costs and improvement of construction properties [4-7]. Some of the parts of structures working in water environment may require repair works. Among three main methods of underwater welding, dry, local dry cavity and wet welding, the most common is wet welding, where the electric arc and the joint are with direct contact with water [8-10]. Wet welding could be carried out by using covered electrodes, flux cored wires and, more rarely, other welding processes [11-15]. The schema of wet welding by covered electrodes is presented in Fig. 1.

Water as welding environment causes a lot of problems with the quality of obtained joints and their mechanical properties. The most important problem in underwater welding conditions is the tendency to cold cracking [8,13,16,17]. The high cooling rate causes presence of martensitic structures in HAZ. The structure of welded joints is characterized by high hardness and low plasticity. The second of the main problems is presence of diffusible hydrogen content in weld metal. The hydrogen sources are water vapor and covering of electrodes [18]. The hydrogen content in the joints made in wet welding conditions is in the range of 50-80 ml/100g of deposited metal in comparison with H5 or H10 levels for onshore welds [19-23].

The welding environment significantly limits the possibility of reducing the susceptibility to cracking by minimizing the impact of cooling rate and hydrogen content. To obtain high carbon equivalent steel welded joints with good quality it is essential to improve consumables and technologies and develop new ones [24]. There are some studies for using induction heating [25], mechanical constraint support [26] and ultrasonic assistance [27] for improve weldability of underwater joints. One of the conventional method to decrease susceptibility to cold cracking is heat treatment. This process is well known in air conditions, however water makes it impossible to do in traditional way. Temper bead welding could produce similar results by local heat treatment of the joint, that extends $t_{8/5}$ cooling time [28-30]. There are some studies showed that welding with temper beads can be an effective method to improve the weldability of steel in water environment [28,30], however all investigated materials are characterized with Ce_{IIW} lower than 0.4%.

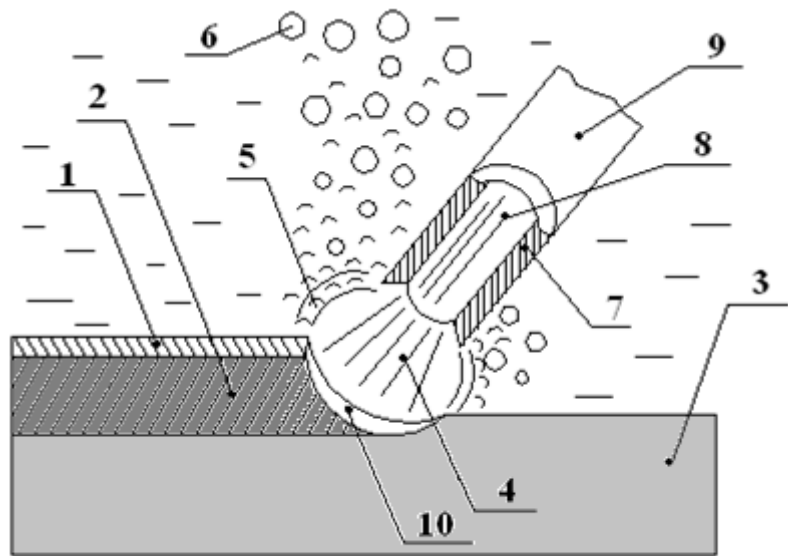

Fig. 1. Wet welding by covered electrodes schema, 1–slag, 2–weld, 3–base material, 4–electric arc, 5–water vapor, 6–gas bubbles, 7–flux coating, 8– wire, 9–consumable electrode, 10–liquid metal [4]

Information of the S460N steel weldability in the published literature is limited and, based on its chemical composition and structure, the steel should be treated as a material with poor weldability. Typical welding procedures for this steel in the air require pre-heating to a temperature dependent on the thickness of the elements and the type of joint (thermal severity) [31,32].

The aim of the work was to evaluation effectiveness of TBW application in wet welding conditions for joints from S460N steel welded by covered electrodes. The research also allow to determine the beneficial, from the weldability point of view, range of pitches between two beads.

MATERIALS AND EXPERIMENTAL PROCEDURE

The HSLA S460N steel was selected for the research, because it is used in offshore structures. The investigated steel is characterized by high susceptibility to cold cracking in wet welding by covered electrodes [31], so it is necessary to look for solutions to improve its



weldability in water environment. For studies S460N plates of 12 mm thickness was chosen. Its chemical composition and mechanical properties are presented in Tables 1 and 2.

Table 1. Chemical composition and carbon equivalent of S460N steel, wt % acc. to control analysis

C	Si	Mn	P	Cr	Mo	Ni	Al	Cu	V	C _{eIIW}
0.16	0.53	1.51	0.02	0.07	0.03	0.05	0.033	0.13	0.097	0.464

Table 2. Mechanical properties of S460N steel acc. to control analysis

R _e , MPa	R _m , MPa	A, %
511	626	27.3

Lincoln Electric Omnia rutile electrodes (E 42 0RC 11) with diameter of 4.0 mm were chosen as the filler material. These electrodes provide good plastic properties of the weld metal and minimize the susceptibility to cold cracking. Chemical composition and selected mechanical properties of deposited metal are presented in Table 3.

Table 3. Chemical composition (wt %) and selected mechanical properties of Omnia Rutile Electrodes acc. to manufacturer data

C	Mn	Si	R _e , MPa	R _m , MPa	A, %
0.07	0.55	0.44	503	538	26

Weld beads were made on 100 mm x 200 mm sections. Welds were laid in non-parallel directions with methodology used by Aloraier et al. [29]. The aim of pad welding was to obtain different distances between the axes of the beads (pitch). The second bead was laid 120 s after welding of the first bead. The schema of making test welds is presented in Fig. 2.

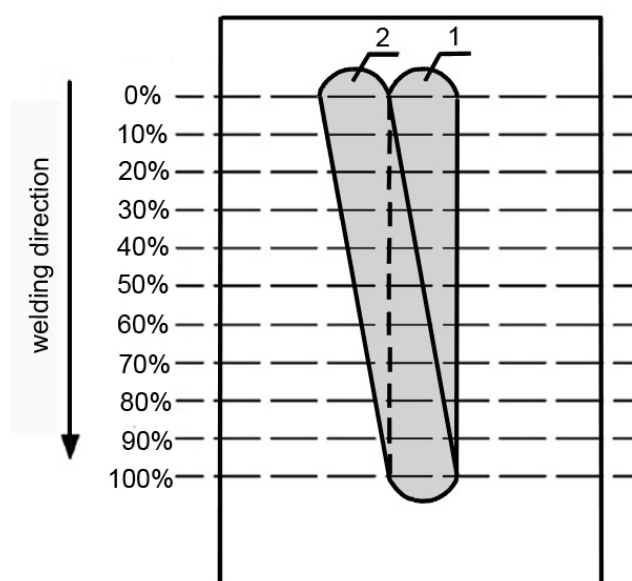

Fig. 2. Schema of the temper bead welding specimens; 1 – first bead, 2 – second bead

The bead welds were made with DC- polarity. The second bead was made with a higher value of heat input to increase the efficiency of thermal effect on the first-tempered bead (Table 4). Heat input values for welding in water environment have been calculated by the formula without including efficiency factor, by the formula: $ql = U \cdot I / V$.

Table 4. Welding parameters of Temper Bead Welding tests

Specimen no.	Bead no.	I A	U V	V mm/s	ql $\frac{kJ}{mm}$
1	1	168	25.0	5.34	0.79
	2	192	26.0	5.35	0.93
2	1	164	28.0	5.21	0.88
	2	196	26.5	5.40	0.96
3	1	172	25.0	4.83	0.89
	2	224	26.0	6.18	0.94

METALLOGRAPHIC EXAMINATIONS

The macroscopic metallographic examinations was performed in accordance with the standard guidelines EN ISO 17639. The aim of macroscopic testing was to evaluate the pitch between two beads. The test welds were cut perpendicular to the axis of the first bead weld. Fig. 3 shows the exemplary results of the macroscopic examinations.

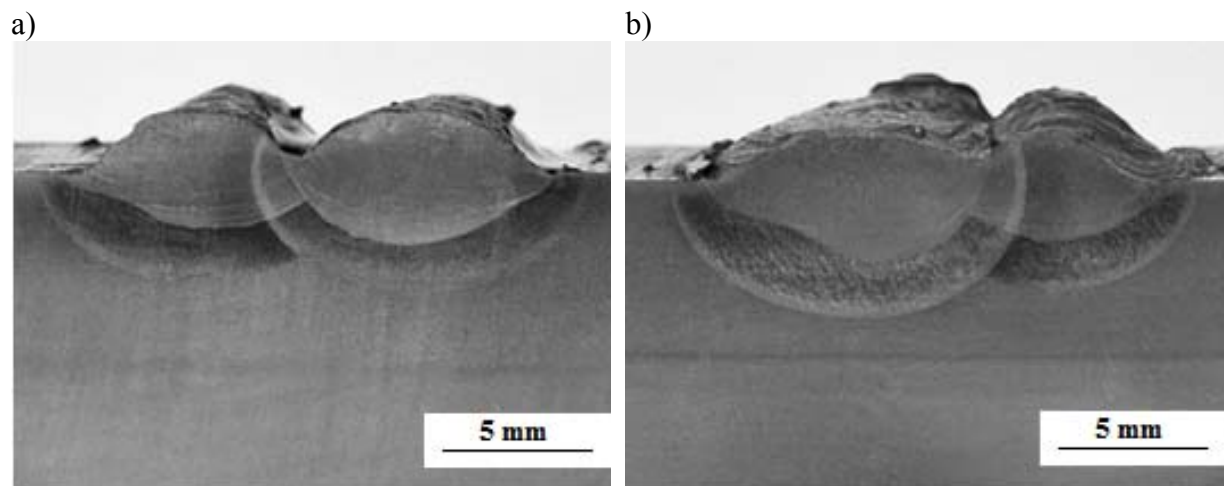

Fig. 3. Cross-section of the TBW specimens; a) specimen 1, pitch 34%, no imperfections, b) specimen 3, pitch 26%, no imperfections. Etch. Nital

For the microscopic testing and hardness measurements cross-sections with the following pitches were selected: 11%, 20%, 26%, 34%, 45%, 66%, 87%, 100%. The aim of metallographic microscopic testing was structural analysis of pad welds and heat affected zones. Structural changes resulting from the heat treatment from second bead were analyzed. The tests were carried out in zones presented in Fig 4.

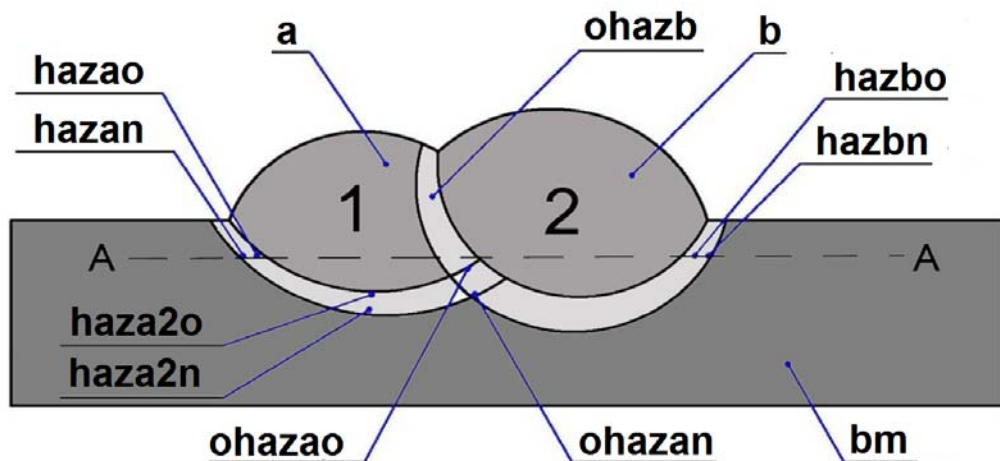

Fig. 4. Hardness measurement areas – TBW specimens, bm – base material, a – 1st padding weld, b – 2nd padding weld, haza – HAZ of 1st padding weld, hazao – overheated area of HAZ of 1st padding weld, hazan – normalization area of HAZ of 1st padding weld, hazb – HAZ of 2nd padding weld, hazbo – overheated area of HAZ of 2nd padding weld, hazbn – normalization area of HAZ of 2nd padding weld, ohazb - area of hazb overlapping 1st padding weld, ohazan – normalization area of overlapping haza and hazb, ohazao – overheated area of overlapping haza and hazb, haza2o – overheated area of HAZ of 1st padding weld in the weld axis, haz2n – normalization area of HAZ of 1st padding weld in the weld axis [28]

All specimens showed changes due to the tempering effect from the second bead. These changes consisted in the partial disappearance of dendritic structure of first pad weld and the formation of a ferritic fine-grained structure. However, no significant changes were observed in the HAZ microstructure of the base weld. In some specimens the presence of microcracks was observed. These cracks occurred in the HAZ and propagated along of the fusion line in overheated zone of HAZ. This phenomenon is particularly undesirable, as the used temper bead welding technique cannot repair this defect, and cracks can even propagate. In Fig. 5., exemplary results of microscopic studies are presented.

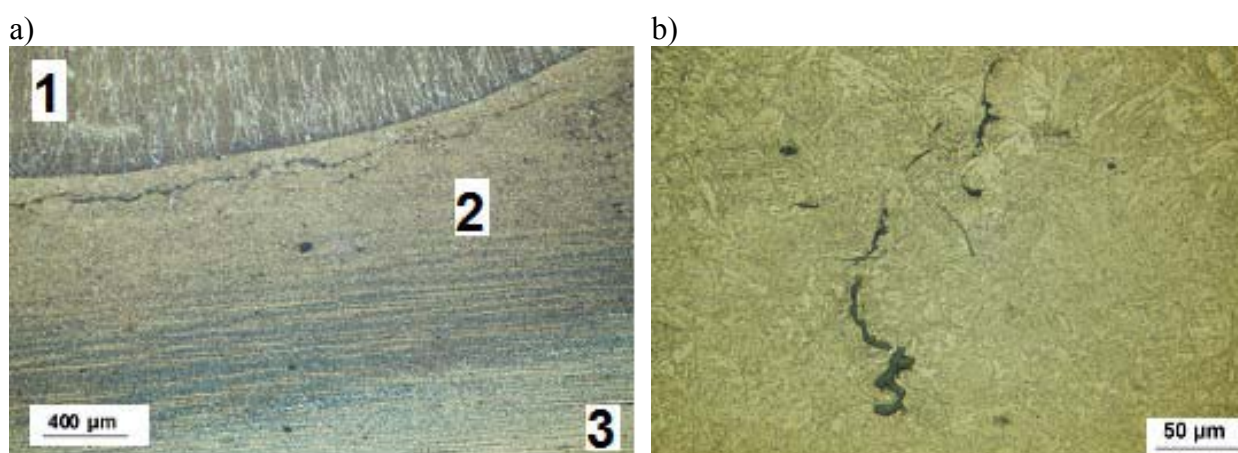
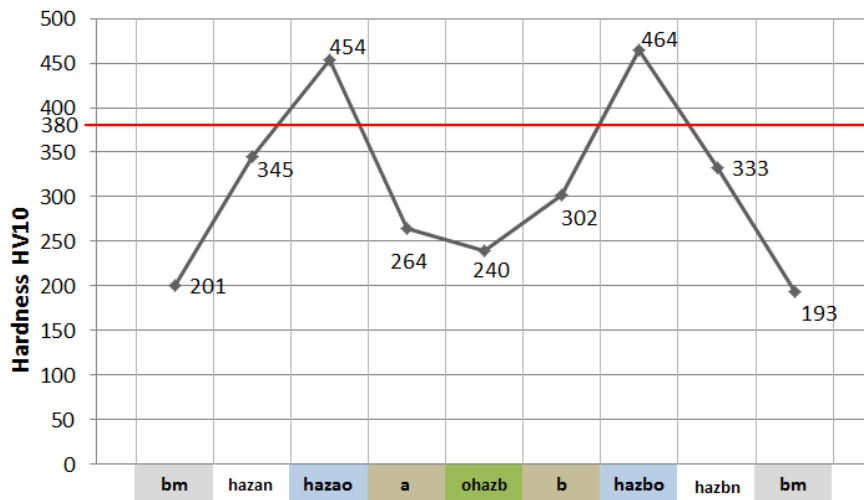

Fig. 5. Microstructures of TBW specimens areas of S460N steel; a) 1 –b, 2 – haza2o, 3 – bm.,, pitch 20%, b) cracks in haza2o, pitch 55%

HARDNESS MEASUREMENTS

Hardness measurements were performed on cross-sections with the selected pitches in areas presented in Fig. 4. Maximum HAZ hardness values are assumed by the EN-ISO 15614-1 at level 380 HV10. Exemplary hardness measurement results are presented in Fig. 6. In Fig. 7 hardness distribution for specimens with different overlap values at areas haza2o and haza2n are presented. In this two areas the tempering mechanism from second bead is the most effective.

a)



b)

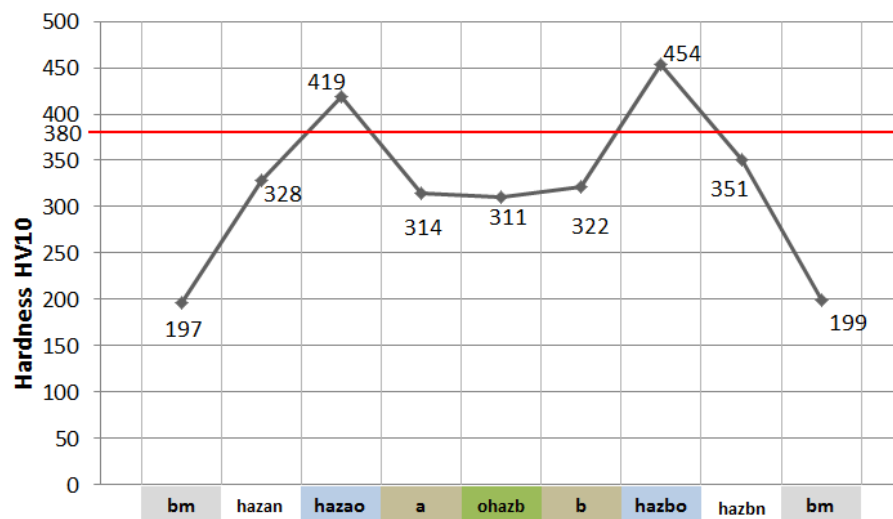

Fig. 6. Hardness distribution across: a) specimen 3, pitch 66%, b) specimen 1, pitch 100%

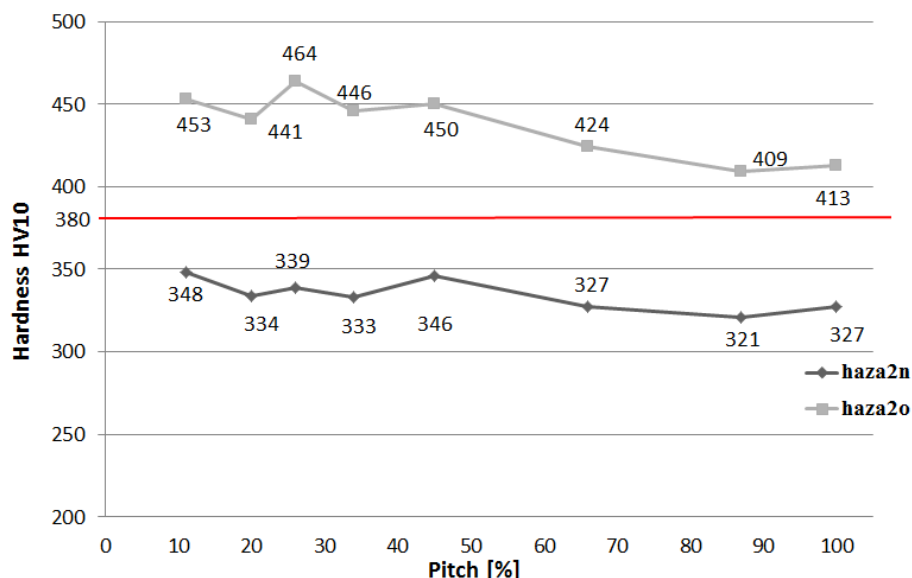

Fig. 7. Hardness distribution at areas haza2o and haza2n (Fig. 4) of the first (tempered) bead for specimens with different pitch values

SUMMARY AND CONCLUSIONS

HSLA S460N steel is characterized by high susceptibility to cold cracking in wet welding conditions [31]. Research has been taken to check the suitability of the use of the temper bead welding technique to improve the weldability of this steel. The experiment showed that hardness in HAZ of first pad welds which were tempered by second bead significantly decreased. However in all specimens the hardness is above the maximum HAZ hardness values assumed at level 380 HV10. There are microcracks in HAZ of tempered beads, however when the pitch increases, the number of cracks decreases.

The TBW technique for S460N steel welded in underwater conditions by covered electrodes is the most effective for pitches in the range 66-100%. The comparison between results of TBW for different steels welded under water is presented in table 5.

Table 5. The effect of TBW on the hardness of various steels [28,30]

Steel	HV10 _{max} in haza2o	Hardness decrease in haza2o after TBW (pitch)	Fulfillment the criterion of EN-ISO 15614-1 (lower than 380 HV10)
S355G10+N	429	67 (100%)	yes
S420G2+M	405	101 (100%)	yes
S460N	464	54 (87%)	no

The results showed, that hardness decrease in S460N steel, however specimens do not fulfill the hardness criterion of EN-ISO 15614-1 (level of 380 HV10).

On the basis of all results, the following conclusions can be drawn:

1. Temper bead welding technique gives significant HAZ hardness decrease of S460N steel welded by covered electrodes in wet welding conditions, but it does not allow the



expected improvement in the weldability, expressed in terms of the maximum hardness of the HAZ, in the conditions of the experiment.

2. The largest decrease in hardness occurred in specimens with the pitches in range 66-100%.
3. Microscopic examination showed the presence of cracks in the area of overlap of heat affected zones. It could be results of presence of cracks after welding the first bead. In this case, TBW technique cannot repair this defect, and cracks can even propagate.

REFERENCES

1. Qiang X., Bijlaard F., Kolstein H.: Elevated-temperature mechanical properties of high strength structural steel S460N: Experimental study and recommendations for fire-resistance design. *Fire Safety Journal*. 55 (2013), 15-21.
2. Topaç M.M., Günal H., Kuralay N.S.: Fatigue failure prediction of a rear axle housing prototype by using finite element analysis. *Engineering Failure Analysis*. 16(5) (2009), 1474-1482.
3. Omajane J., Martikainen J., Kah P.: Weldability of thermo-mechanically rolled steels used in oil and gas offshore structures. *The International Journal of Engineering And Science*. 3(5) (2014), 62-69.
4. Skowrońska B., Szulc J., Chmielewski T., Sałaciński T., Świercz R.: Properties and microstructure of hybride Plasma+MAG welded joints of thermomechanically treated S700MC steel, 27th Anniversary International Conference on Metallurgy and Materials (METAL), Brno, Czech Republik, 2018.
5. Pańcikiewicz K., Tuz L., Żurek Z., Rakoczy Ł.: Optimization of filler metals consumption in the production of welded steel structures. *Advances in Materials Science*. 16(1) (2016), 27-34.
6. Sajek A., Nowacki J.: Comparative evaluation of various experimental and numerical simulation methods for determination of t8/5 cooling times in HPAW process weldments. *Archives of Civil and Mechanical Engineering*. 18(2) (2018), 583-591.
7. Górka J.: Assessment of steel subjected to thermomechanical control process with respect to weldability. *Metals*. 3(3) (2018), 169.
8. Łabanowski J., Prokop-Strzelczyńska K., Rogalski G., Fydrych D.: The effect of wet underwater welding on cold cracking susceptibility of duplex stainless steel. *Advances in Materials Science*. 16(2) (2016), 68-77.
9. Li H. L., Liu D., Guo N., Chen H., Du Y. P., Feng J. C.: The effect of alumino-thermic addition on underwater wet welding process stability. *Journal of Materials Processing Technology*. 245 (2017), 149-156.
10. Purnama D., Winarto W., Susilo F.H.: Mechanical properties of underwater wet welded marine steel plates using different low hydrogen electrodes. *AIP Conference Proceedings* 1977, 030015 (2018), 1-5.
11. Yin Y., Yang X., Cui L., Cao J., Xu W.: Microstructure and mechanical properties of underwater friction taper plug weld on X65 steel with carbon and stainless steel plugs. *Science and Technology of Welding and Joining*. 21(4) (2016), 259-266.

12. Heirani F., Abbasi A., Ardestani M.: Effects of processing parameters on microstructure and mechanical behaviors of underwater friction stir welding of Al5083 alloy. *Journal of Manufacturing Processes*. 25 (2017), 77-84.
13. Rogalski G., Fydrych D., Łabanowski J.: Underwater wet repair welding of API 5L X65M pipeline steel. *Polish Maritime Research*. SI 24 (93) (2017), 188-194.
14. Chen H., Guo N., Shi X., Du Y., Feng J., Wang G.: Effect of water flow on the arc stability and metal transfer in underwater flux-cored wet welding. *Journal of Materials Processing Technology*. 31 (2018), 103-115.
15. Shi Y., Hu Y., Yi Y., Lin S., Li Z.: Porosity and microstructure of underwater wet FCAW of duplex stainless steel. *Metallography, Microstructure, and Analysis*. 6(5) (2017), 383-389.
16. Fydrych D., Łabanowski J., Tomków J., Rogalski G.: Cold cracking of underwater wet welded S355G10+N high strength steel. *Advances in Materials Science*. 15(3) (2015), 48-56.
17. Maksimov S.Y.: Underwater arc welding of higher strength low-alloy steels. *Welding International*. 24(6) (2010), 49-54.
18. Cheng F., Hu S., Gao W., Deng C., Wang D., Jing H.: Diffusible hydrogen content and microstructure characteristic in the joint by underwater shielded metal arc welding. *Transactions of the China Welding Institution*. 35(9) (2014), 45-48.
19. Świerczyńska A., Fydrych D., Rogalski G.: Diffusible hydrogen management in underwater wet self-shielded flux cored arc welding. *International Journal of Hydrogen Energy*. 42(38) (2017), 24532-24540.
20. Fydrych D., Świerczyńska A., Tomków J.: Diffusible hydrogen control in flux cored arc welding process. *Key Engineering Materials*. 597 (2014), 171-178.
21. Schaupp T., Rhode M., Kannengiesser T.: Influence of welding parameters on diffusible hydrogen content in high-strength steel welds using modified spray arc process. *Welding in the World*. 62(1) (2018), 9-18.
22. Pandey C., Mahapatra M., Kumar P., Saini N.: Effect of weld consumable condition of the diffusible hydrogen and subsequent residual stress and flexural strength on multipass welded P91 steels. *Metallurgical and Materials Transactions B*. 49 (2018), 2881.
23. Hanzaei A. T., Marashi S. P. H., Ranjbarnodeh E.: The effect of hydrogen content and welding conditions on the hydrogen induced cracking of the API X70 steel weld. *International Journal of Hydrogen Energy*. 43(19) (2018), 9399-9407.
24. Li H., Liu D., Dong Y., Yan Y., Guo N., Feng J.: Microstructure and mechanical properties of underwater wet welded high-carbon-equivalent steel Q460 using austenitic consumables. *Journal of Materials Processing Technology*. 249 (2017), 149-157.
25. Zhang H.T., Dai X.Y., Feng J.C., Hu L.L.: Preliminary investigation on real-time induction heating-assisted underwater wet welding. *Welding Journal*. 1(2015), 8-15.
26. Wang J., Sun Q., Jiang Y., Zhang T., Ma J., Feng J.: Analysis and improvement of underwater wet welding process stability with static mechanical constraint support. *Journal of Manufacturing Processes*. 34 (2018), 238-250.
27. Wang J., Sun Q., Laijun W., Liu Y., Teng J., Feng J.: Effect of ultrasonic vibration on microstructural evolution and mechanical properties of underwater wet welding joint. *Journal of Materials Processing Technology*. 246 (2017), 157-197.
28. Tomków J., Rogalski G., Fydrych D., Łabanowski J.: Improvement of S355G10+N steel weldability in water environment by Temper Bead Welding. *Journal of Materials Processing Technology*. 262 (2018), 372-381.



29. Aloraier A., Ibrahim R., Thomson P.: FCAW process to avoid the use of post weld heat treatment: *International Journal of Pressure Vessels and Piping*. 83(5) (2006), 394-398.
30. Fydrych D., Świerczyńska A., Rogalski G., Łabanowski J.: Temper bead welding of S420G2+M steel in water environment. *Advances in Materials Science*. 16(4) (2016), 5-16.
31. Tomków J., Łabanowski J., Fydrych D., Rogalski G.: Cold cracking of S460N steel welded in water environment. *Polish Maritime Research*. 25, 3 (99) (2018), 131-136
32. Schröter F., Lehnert T.: Trends in the application of high-performance steel in European bridge building. *The Eight International Conference „Bridges in Banube Basin”*. (2013), 33-50.