

Received August 19, 2021, accepted September 9, 2021, date of publication September 13, 2021, date of current version September 24, 2021.

Digital Object Identifier 10.1109/ACCESS.2021.3112237

Design of a Compact Planar Transmission Line for Miniaturized Rat-Race Coupler With Harmonics Suppression

ALI LALBAKSHI^{1,2}, (Member, IEEE), GOLSHAN MOHAMADPOUR³,
SAEED ROSHANI⁴, (Member, IEEE), MOHAMMAD AMI⁴, SOBHAN ROSHANI⁴,
ABU SADAT MD. SAYEM^{1,2}, MOHAMMAD ALIBAKHSHIKENARI⁵, (Member, IEEE),
AND SLAWOMIR KOZIEL^{6,7}, (Senior Member, IEEE)

¹School of Engineering, Macquarie University, Sydney, NSW 2109, Australia

²School of Electrical and Data Engineering, University of Technology Sydney, Ultimo, NSW 2007, Australia

³Department of Electrical Engineering, Lorestan University, Khorramabad, Iran

⁴Department of Electrical Engineering, Kermanshah Branch, Islamic Azad University, Kermanshah, Iran

⁵Department of Signal Theory and Communications, Universidad Carlos III de Madrid, 28911 Leganés, Madrid, Spain

⁶Department of Engineering, Reykjavik University, 102 Reykjavik, Iceland

⁷Faculty of Electronics, Telecommunications and Informatics, Gdańsk University of Technology, 80-233 Gdańsk, Poland

Corresponding author: Saeed Roshani (s_roshani@yahoo.com)

This work was supported in part by the Icelandic Centre for Research (RANNIS) Grant 206606051, and in part by the National Science Centre of Poland Grant 2017/37/B/ST7/00563.

ABSTRACT This paper presents an elegant yet straightforward design procedure for a compact rat-race coupler (RRC) with an extended harmonic suppression. The coupler's conventional $\lambda/4$ transmission lines (TLs) are replaced by a specialized TL that offers significant size reduction and harmonic elimination capabilities in the proposed approach. The design procedure is verified through the theoretical, circuit, and electromagnetic (EM) analyses, showing excellent agreement among different analyses and the measured results. The circuit and EM results show that the proposed TL replicates the same frequency behaviour of the conventional one at the design frequency of 1.8 GHz while enables harmonic suppression up to the 7th harmonic and a size reduction of 74%. According to the measured results, the RRC has a fractional bandwidth of 20%, with input insertion losses of around 0.2 dB and isolation level better than 35 dB. Furthermore, the total footprint of the proposed RRC is only 31.7 mm \times 15.9 mm, corresponding to 0.28 $\lambda \times$ 0.14 λ , where λ is the guided wavelength at 1.8 GHz.

INDEX TERMS Transmission line, rat-race coupler, size reduction, harmonics suppression.

I. INTRODUCTION

Microstrip rat-race couplers (RRC), also known as hybrid ring couplers, are widely used microwave circuits for dividing/combining microwave input power in their four ports [1]. Conventional RRCs are composed of six 90° transmission lines (TLs), making them undesirably large components and susceptible to unwanted harmonics. An extensive number of attempts have been made to minimize the circuit size and attenuate the unwanted harmonics of the conventional RRC [2]. Artificial TLs were used to achieve 64% footprint reduction based on planar circuit lines without external lumped components [2].

The associate editor coordinating the review of this manuscript and approving it for publication was Qi Luo¹.

In an attempt for size reduction as well as harmonic suppression, slow-wave transmission lines are used to develop an RRC with the 5th harmonic suppression capability [3]. The compact branch-line coupler (BLC) application with low pass filter and open stubs was demonstrated, resulting in a significant size reduction and harmonic suppression [4]. Despite promising results in [3] and [4], the former results in a complex design and the latter has a high pass-band insertion loss.

In a different approach, external lumped reactive components are introduced in the RRC configuration in [5]–[8], where a considerable harmonic rejection and miniaturization up to 60% compared with the conventional RRC are reported. But, the usage of external lumped reactive components is not desirable in fabrication processes [8].

In [9], a planar discontinuous microstrip lines are used for size reduction of the BLC, which more than 60% size reduction is achieved compared to the normal coupler. But, this circuit does not have harmonics elimination.

In [10], shorted trans-directional (TRD) coupled lines along with T-type transmission have been used to develop an RRC, achieving a size reduction of 73% and harmonic suppression up to the fifth harmonic. However, several capacitors and holes are associated with the TRD that may not be desirable for some applications due to the fabrication complexity.

In [11], compensated spiral compact microstrip resonant cells were proposed in the RRC structure for 45% miniaturization and suppressing the third harmonic. However, applied resonator cells in this structure lead to high passband insertion loss.

In several studies [12], electromagnetic bandgap and defected ground structure techniques have been used for harmonics suppression and size reduction. In [12], photonic bandgap (PBG) cells have been utilized to design a small RRC with 23% size reduction. Apart from RRC, the PBG has a wide application in other passive microwave devices, such as various types of power dividers, filters, and frequency selective surfaces [13]–[17]. In [18], an RRC was designed based on defected ground structure technique, eliminating the third harmonic. T-shaped PBG cells were proposed to reduce the strip section length for the size reduction of RRCs [19]. While an acceptable size reduction has been demonstrated based on PBG, its complex manufacturing is not suitable for many applications [20]. In [21], a compact LC branch line was developed based on miniaturizing inductor and two transmission lines for harmonics removal and miniaturization.

Besides, neural networks, which are useful tools in solving the engineering problems [22]–[26] have been recently used to model the power dividers and couplers [27]. In [27] a power divider is designed and modeled using artificial intelligence, however designing of a coupler or divider by neural networks is not straightforward and the method is mostly suitable for modeling of the device.

In this work, a highly miniaturized RRC capable of rejecting unwanted harmonics up to the 7th harmonic is presented, fabricated, and successfully tested. In this design, the proposed TL comprises three sections; two high impedance lines, loaded by a low-impedance line at the middle, where the conventional $\lambda/4$ long lines are made redundant.

II. DESIGN PROCEDURE

The design procedure of the proposed RRC is shown in Fig. 1 through 6 steps. In step 1, an LC equivalent circuit of the compact TL with the desired response is presented. The proposed LC model shows a wide suppression. In step 2, the realization of the proposed compact TL is presented in the schematic environment of the ADS software as a circuit simulation. In step 3, the proposed compact TL is designed in the momentum environment of ADS software, showing good agreement with the circuit simulation. Subsequently,

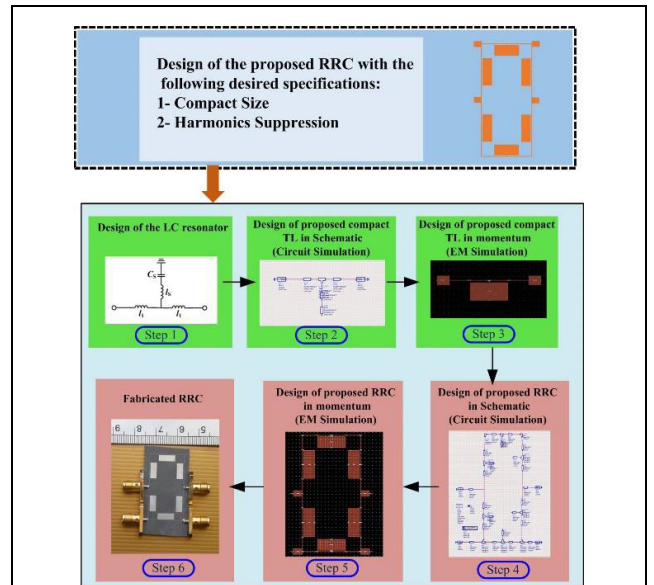

FIGURE 1. Design Procedure of the proposed RRC.

the proposed compact TL is utilized in the conventional RRC to make a compact and harmonic-free RRC as shown in step 4. Next, the circuit simulation and EM simulation of the proposed RRC is performed in steps 4 and 5, respectively. Finally, the proposed RRC was fabricated on a RT/Duroid substrate and measured as shown in step 6.

III. PROPOSED COMPACT TRANSMISSION LINE DESIGN

Fig. 2(a) shows the conventional quarter-wavelength TL with a length of $\lambda/4$ line (30.3 mm) at 1.8 GHz. The substrate used in this design has a permittivity of 2.2, and a thickness of 20 mil. Fig. 2(b) shows the proposed layout consisting

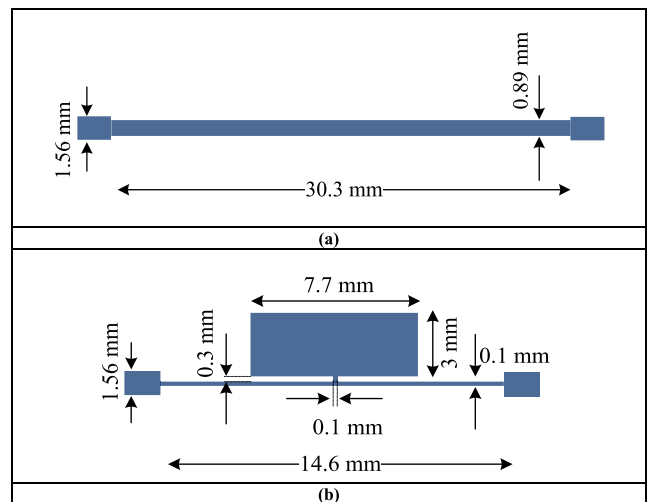

FIGURE 2. (a) Conventional $\lambda/4$ line with 70.7 Ω characteristic impedance, (b) the proposed compact line at 1.8 GHz. The input and output ports are considered 50 ohms in simulations for both transmission lines. According to the substrate specifications, 50 ohms is achieved for 1.56 mm width of the transmission line.

of two high impedance lines loaded by a low-impedance line placed at the center. According to the fabrication limits, the minimum width used is equal to 0.1 mm, corresponding to a 167.5 Ω high impedance line. This high impedance line is loaded by a low impedance line with 7.7 mm thickness at middle, which equals to 14.3 Ω line.

Both the conventional λ/4 line and the proposed line have input and output ports with 50 ohms impedance. According to the substrate specifications, 50 ohms is achieved for 1.56 mm width of the transmission line.

The LC equivalent circuit of the proposed compact TL is extracted and shown in Fig. 3(a) and (b). The values of the lumped inductors and a capacitors are $l_1 = 8$ nH, $l_s = 0.2$ nH and $C_s = 0.9$ pF. The frequency responses of the extracted LC equivalent are shown in Fig. 3(c).

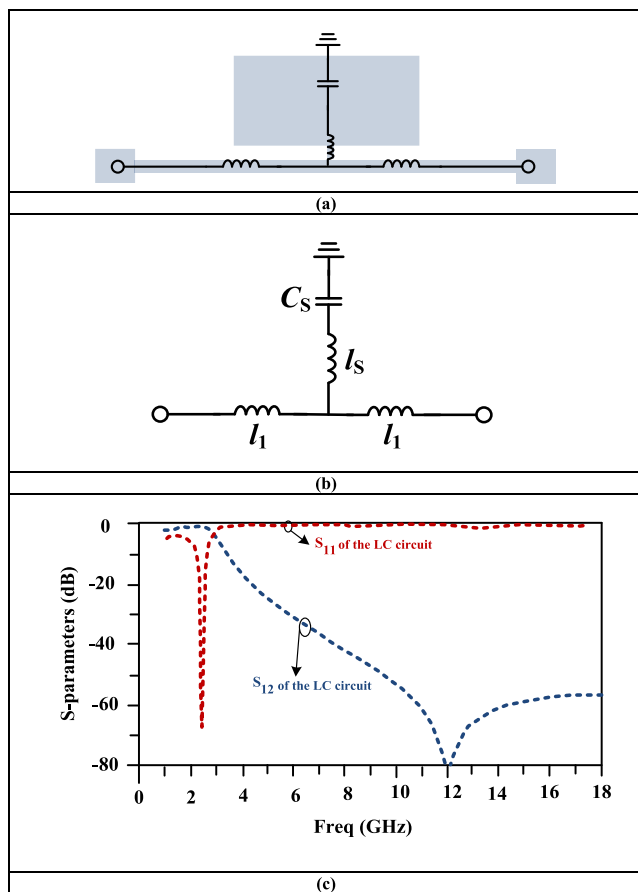

FIGURE 3. (a) The extraction process and (b) extracted LC equivalent circuit of the proposed compact TL and (c) frequency response.

To show the theoretical relation of frequency response for the presented resonator, the transfer function of this LC model is extracted as written in equation (1), as shown at the bottom of the next page.

The bode plot for the obtained transfer function is plotted by MATLAB software and depicted in Fig. 4. There is good agreement between the simulation results of the LC model frequency response and the Bode plot of the extracted transfer function, validating the theoretical analysis.

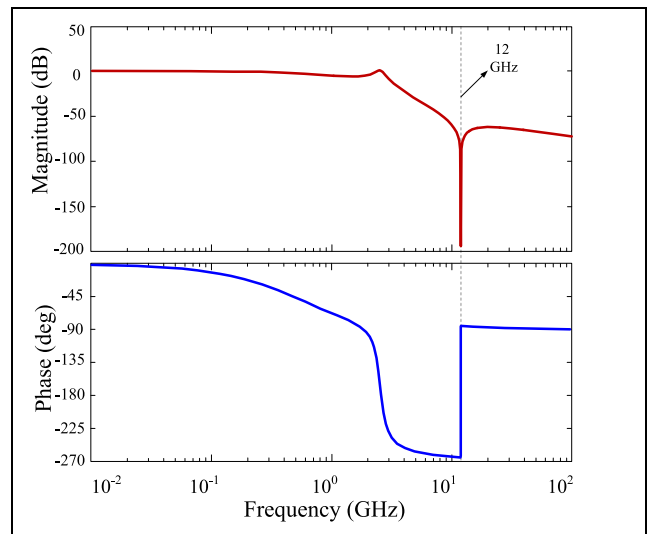

FIGURE 4. The Bode plot of the extracted transfer function.

In this equivalent circuit, C_s and l_s model the open ended stub of the TL, generating a transmission zero at f_{0s} calculated by (2) as depicted in Fig. 5. This transmission zero would then contribute to largening the suppression band of the power divider. Furthermore, the high impedance lines in Fig. 3(a) are modeled by two l_1 inductors in the LC model, acting as a three-pole lowpass filter (LPF) in conjunction with C_s . The bandwidth of the TL equals the LPF cut-off frequency (f_c) estimated by (3). In detail, l_s has a negligible contribution in locating cut-off frequency of the filter; firstly, because the capacitive effect is dominant in the open stub, and secondly because l_s is considerably smaller than l_1 .

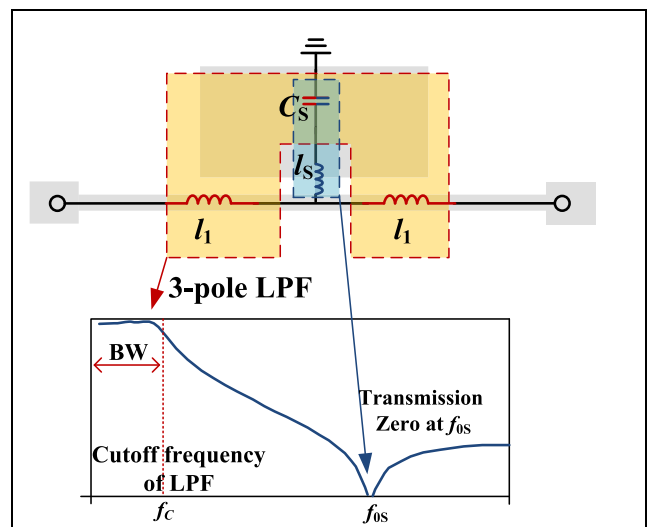

FIGURE 5. The components of the proposed compact TL resonator.

The components of the proposed compact TL resonator are graphically explained in Fig. 5.

$$f_c = BW = 1/\pi \sqrt{2l_1 C_s} \tag{2}$$

$$f_{0s} = 1/2\pi \sqrt{l_s C_s} \tag{3}$$

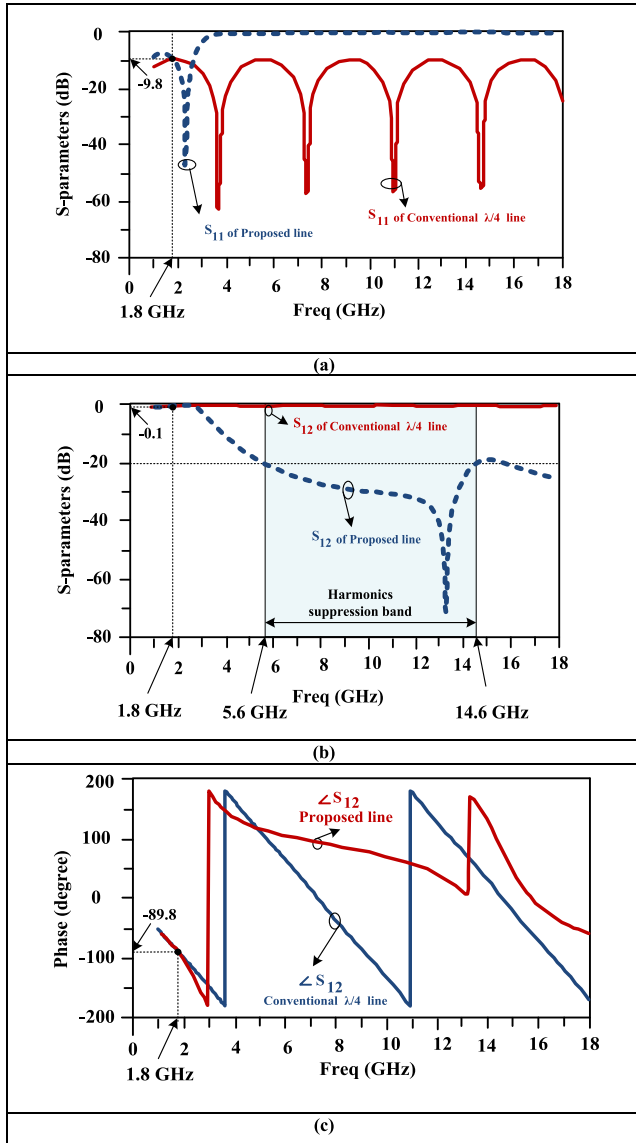

FIGURE 6. Scattering parameters of the conventional $\lambda/4$ line and the proposed compact TL. (a) The magnitude of S_{11} , (b) magnitude of S_{12} , and (c) phase of S_{12} . As seen in this figure, the phase and magnitude of the proposed transmission line and the conventional $\lambda/4$ line have the same values at the operating frequency of 1.8 GHz.

For the designed compact TL resonator, the values of the lumped inductors and the capacitor are selected as $l_1 = 8$ nH, $l_5 = 0.2$ nH and $C_5 = 0.9$ pF. So, according to equations (2) and (3) the calculated bandwidth (BW) and transmission zero (f_{0S}) are 2.7 GHz and 11.9 GHz, respectively, which are very close to the simulation results of BW = 2.8 GHz and $f_{0S} = 11.9$ GHz, verifying the accuracy of the circuit modeling.

The scattering parameters of the conventional $\lambda/4$ line and the proposed compact TL are illustrated in Fig. 6.

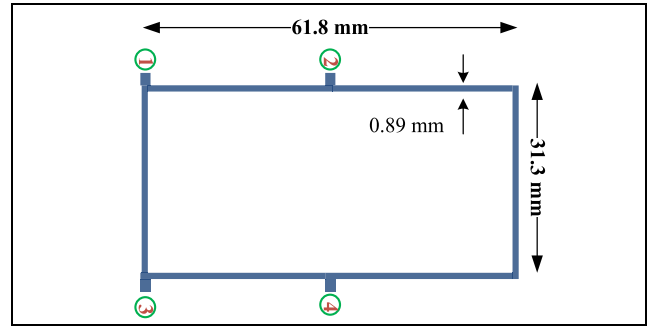

FIGURE 7. The structure of the conventional RRC.

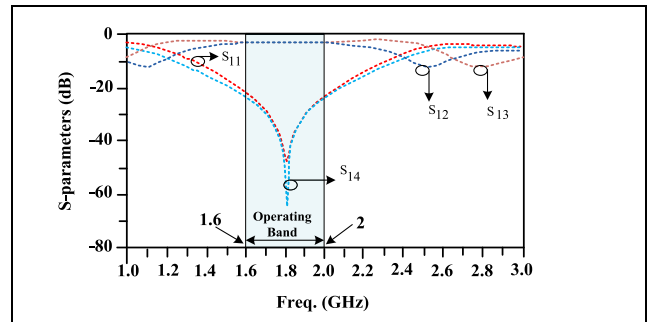

FIGURE 8. The scattering parameters of the conventional RRC. In the operating bandwidth, the insertion losses (S_{12} and S_{13}) are less than 0.3 dB while S_{11} and S_{14} are considered less than -20 dB, which the operating bandwidth is highlighted with a blue box in this figure. The FBW is calculated 22% for the conventional RRC.

As results in Fig. 6 show, the phase and magnitude of the proposed transmission line and the conventional $\lambda/4$ line have the same values at the operating frequency of 1.8 GHz. The magnitude of the S_{11} of the conventional $\lambda/4$ and the proposed lines are depicted in Fig. 6(a), which have the same values of -9.8 dB at 1.8 GHz. Similarly, the magnitude of the S_{12} of the conventional $\lambda/4$ and the proposed TL are depicted in Fig. 6(b), having the same value of -0.2 dB at 1.8 GHz. The same can be said for the S_{12} phase curves shown in Fig. 6(c), where both lines have the same value of -89.8 degrees at 1.8 GHz.

To summary, it is confirmed that the proposed TL line replicates the same frequency behavior of the conventional lines at the operating frequency of 1.8 GHz. Additionally, it has an additive advantage of harmonic elimination over the frequency window of 5.6 GHz up to 14.6 GHz with high attenuation level (more than 20 dB), as depicted in Fig. 6.

IV. CONVENTIONAL RAT RACE COUPLER DESIGN

The structure of the conventional RRC, designed at 1.8 GHz is illustrated in Fig. 7. This coupler consists of six quarter-wavelength conventional TLs with $\sqrt{2} Z_0$ (70.7 Ω) characteristic impedance.

$$H(s) = \frac{1.667 \times 10^{-08} s^4 + 4.167 \times 10^{09} s^3 + 2.604 \times 10^{26} s^2 + 2.48 \times 10^{31} s + 1.44 \times 10^{48}}{s^4 + 1.75 \times 10^{18} s^3 + 1.06 \times 10^{28} s^2 + 4.63 \times 10^{38} s + 1.44 \times 10^{48}} \quad (1)$$

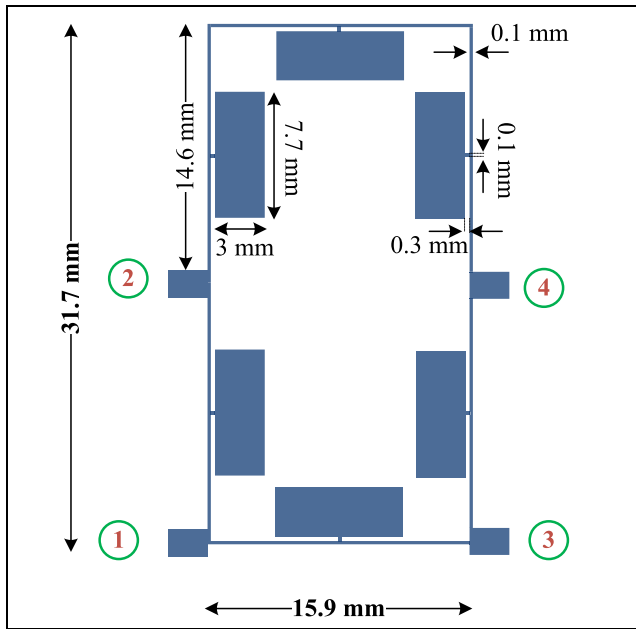

FIGURE 9. The schematic diagram of the proposed RRC.

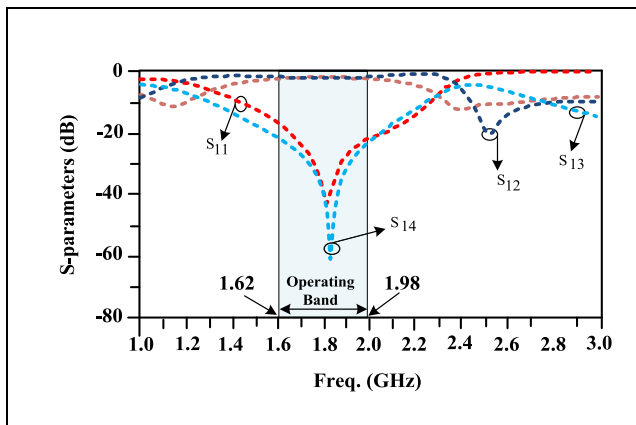

FIGURE 10. The scattering parameters of the proposed RRC in the vicinity of the operational frequency band. The insertion losses (S_{12} and S_{13}) are less than 0.3 dB, and the S_{11} and S_{14} are better less than -20 dB, over the operating frequency band of 20%.

In this conventional design, we use the same RT/Duroid substrate with a thickness of 20 mil, where the $\lambda/4$ line has a physical length of 30.3 mm at 1.8 GHz with a 70.7Ω characteristic impedance, corresponding to 0.89 mm width. The overall size of the conventional RRC is 61.8 mm \times 31.3 mm ($0.50 \lambda \times 0.25\lambda$).

The scattering parameters of the conventional RRC is illustrated in Fig. 8. As can be seen from this figure, the coupler operates at 1.8 GHz, where the input return loss and the ports isolation are better than 48 dB and 65 dB, respectively. The insertion losses of other ports are in a very good range dB ($S_{12} = S_{13} = -3.1$ dB).

As highlighted in Fig. 7, the insertion losses (S_{12} and S_{13}) of the conventional RRC are less than 0.3 dB throughout

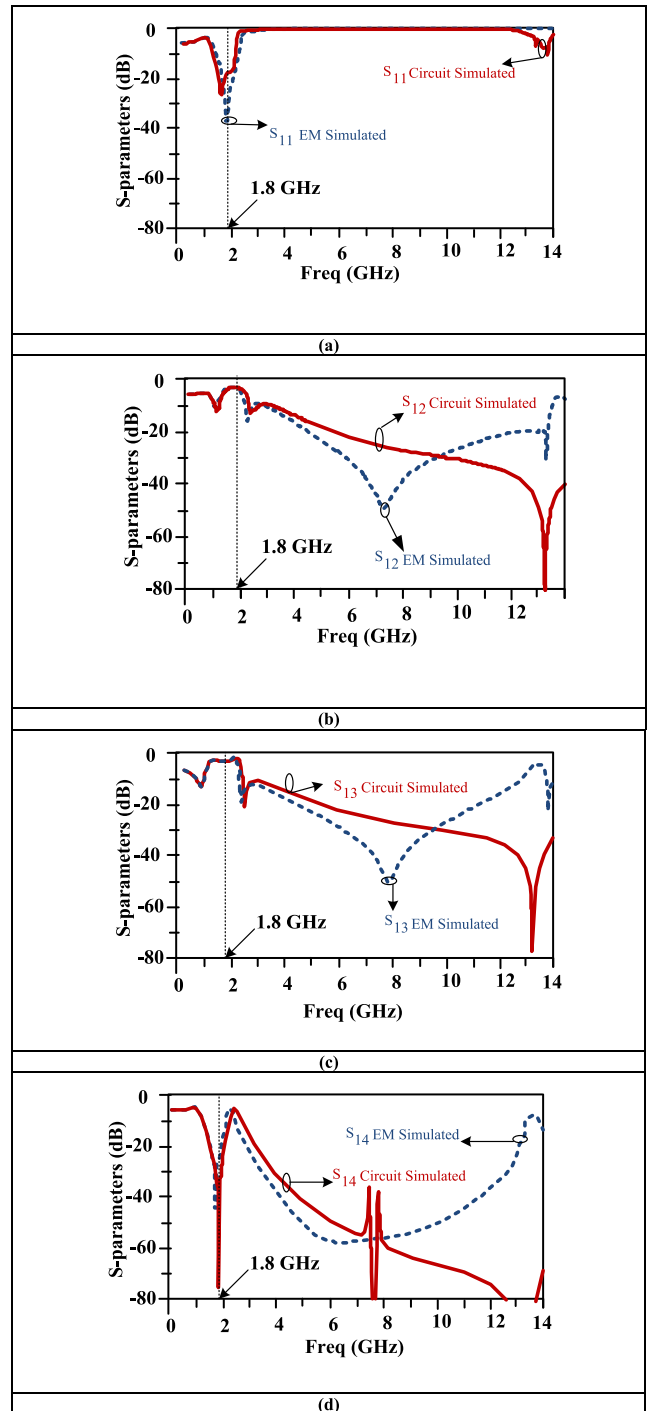

FIGURE 11. The scattering parameters of the proposed RRC. (a) S_{11} (b) S_{12} (c) S_{13} (d) S_{14} .

the fractional bandwidth of 22%, extending from 1.6 GHz to 2 GHz with S_{11} and S_{14} better than 20 dB.

V. DESIGN OF THE PROPOSED RAT RACE COUPLER

In order to reduce the size of the conventional RRC designed in the last section and to eliminate the unwanted higher-order harmonics, the conventional long $\lambda/4$ lines are replaced by

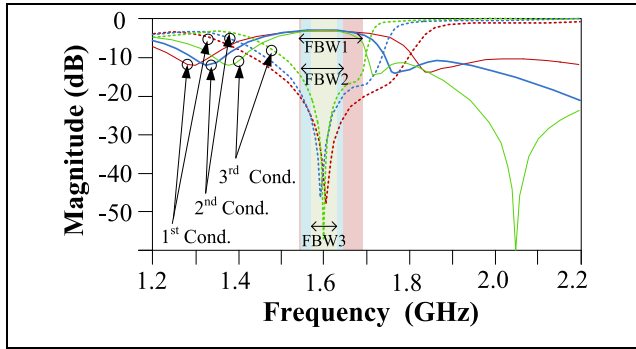

FIGURE 12. The effects of C_s and I_s values on the FBW of the designed RRC. In this Figure, the values C_s and I_s in three different conditions are investigated, which these conditions are 1st condition: $C_s = 1.2$ pF, $I_s = 0.2$ nH, 2nd condition: $C_s = 1$ pF, $I_s = 2$ nH, and 3rd condition $C_s = 0.7$ pF, $I_s = 5$ nH. The obtained FBW for three conditions are respectively, $FBW_1 = 17.4\%$, $FBW_2 = 10.5\%$, $FBW_3 = 6.7\%$. In the calculation of the FBW, the insertion losses (S_{12} and S_{13}) are less than 0.3 dB, while S_{11} and S_{14} are considered less than -20 dB, which the operating bandwidths are highlighted with colored boxes in the figure.

TABLE 1. Performance summary of the proposed RRC at the design frequency.

	f (GHz)	S_{11} (dB)	S_{12} (dB)	S_{13} (dB)	S_{14} (dB)
Proposed RRC	1.8	-35	-3.06	-3.07	-60

TABLE 2. The performance summary of the proposed RRC.

Type of Coupler	f (GHz)	Size reduction	Harmonics Suppression					
			2 nd	3 rd	4 th	5 th	6 th	7 th
Proposed RRC	1.8	74 %	16 dB	19 dB	24 dB	29 dB	32 dB	38 dB
Conventional RRC	1.8	-	-	-	-	-	-	-

the proposed compact TLs. The schematic diagram of the proposed RRC is illustrated in Fig. 9.

The proposed coupler only occupies $31.7 \text{ mm} \times 15.9 \text{ mm}$ ($0.28 \lambda \times 0.14 \lambda$, where λ is the guided wavelength at 1.8 GHz). Thus, compared to the conventional one, the proposed device has a 74% size reduction. The scattering parameters of the proposed RRC are illustrated in Fig. 10.

As shown in Fig. 9, the scattering parameters of the new RRC with the proposed TL are very similar to the conventional coupler over its operating frequency band, with insertion losses and isolation better than 0.3 dB and 20 dB, respectively. The new coupler has a 20% fractional bandwidth, extending from 1.62 GHz $-$ 1.98 GHz.

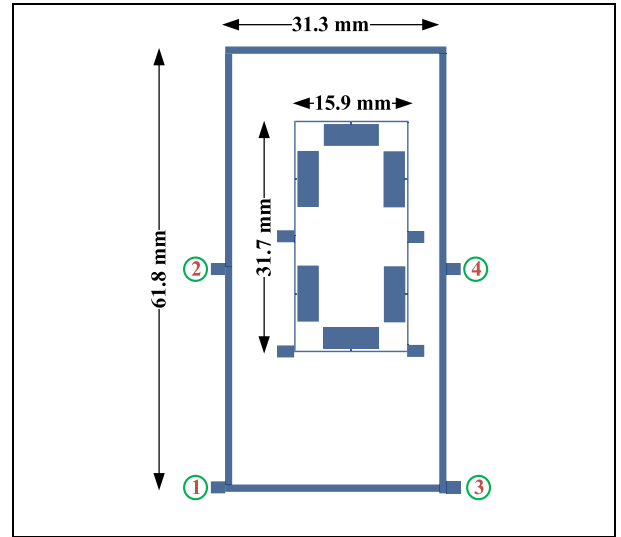

FIGURE 13. Size comparison of the proposed RRC and conventional one.

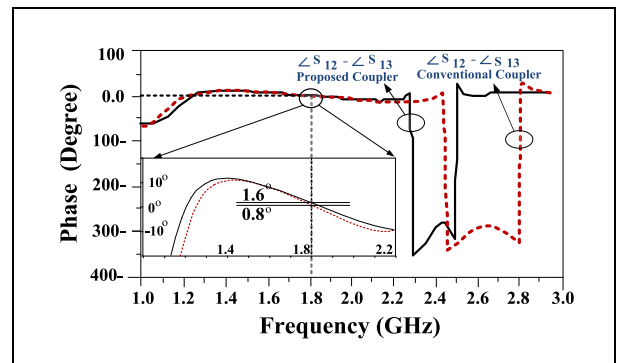

FIGURE 14. The phase difference between output ports for the conventional coupler and the proposed coupler. In this Figure, the dashed line plot shows the phase difference of the conventional RRC while the solid line plot shows the phase difference of the proposed RRC. Besides, as shown in the zoomed scale plot of the phase, the values of the phase difference for the conventional and proposed RRC are 0.8° and 1.6° respectively, in the operating frequency.

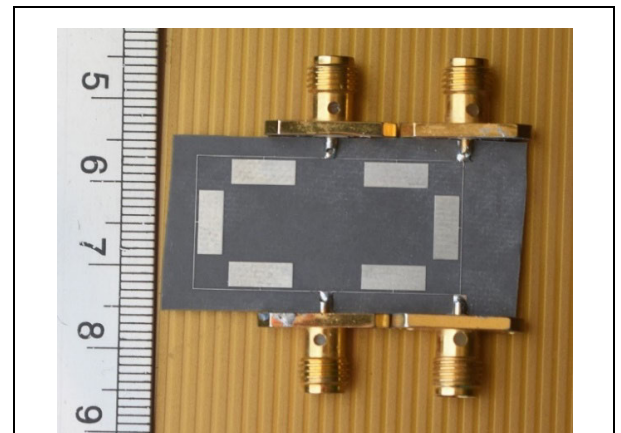

FIGURE 15. A photo of the proposed coupler.

The circuit electromagnetic (EM) simulated results of the proposed RRC are illustrated in Fig. 11.

It can be seen from Fig. 12 that the proposed RRC demonstrates excellent performance at the design frequency

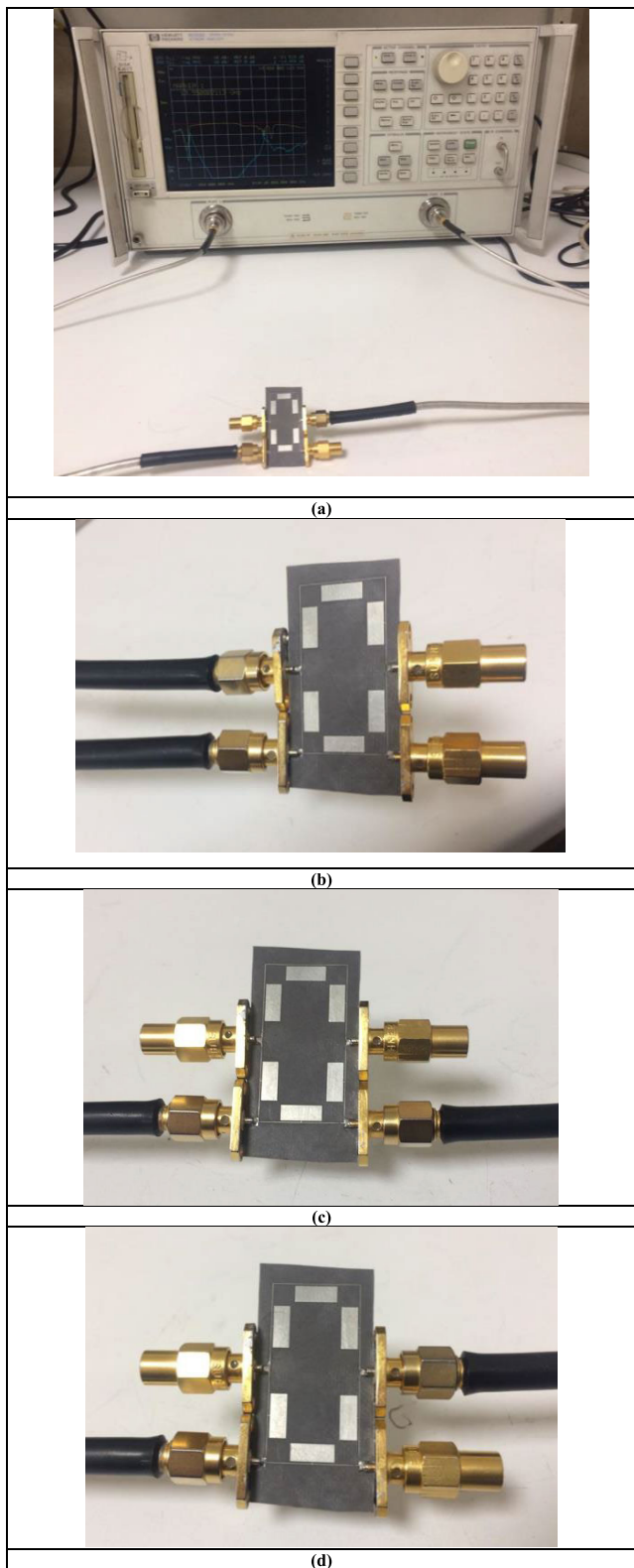

FIGURE 16. (a) The proposed device under test. Measuring the (b) S_{12} , (c) S_{13} , and (d) S_{14} parameters.

of 1.8 GHz. In detail, it has an input return loss (S_{11}) of around 35 dB, a small insertion loss (better than 0.2 dB) between ports 1 and 2, and ports 1 and 3, and excellent

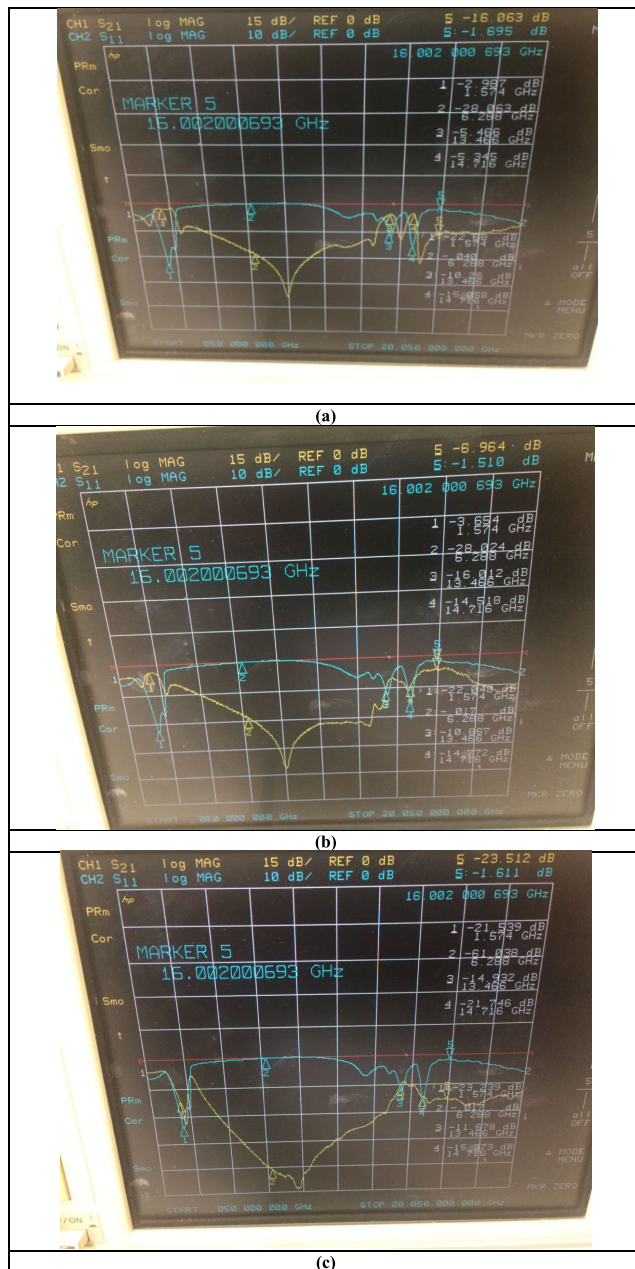

FIGURE 17. The photos of the utilized network analyzer screen during the measurement process of (a) S_{11} and S_{12} , (b) S_{11} and S_{13} , and (c) S_{11} , and S_{14} parameters.

isolation (S_{14}) of around 55 dB at 1.8 GHz. It should be noted that some interblock coupling effects are neglected in the circuit simulation, resulting in some minor out-of-band discrepancies between the EM and circuit simulations.

The proposed coupler has a significant harmonic suppression capability, as demonstrated in Fig. 12. In detail, the 2nd harmonic to the 7th harmonics are suppressed by 16 dB, 19 dB, 24 dB, 29 dB, 32 dB, and the 38 dB, respectively, where the lowest attenuation levels of S_{31} and S_{21} are used. Table 1 shows the performance summary of the proposed RRC at its operating frequency.

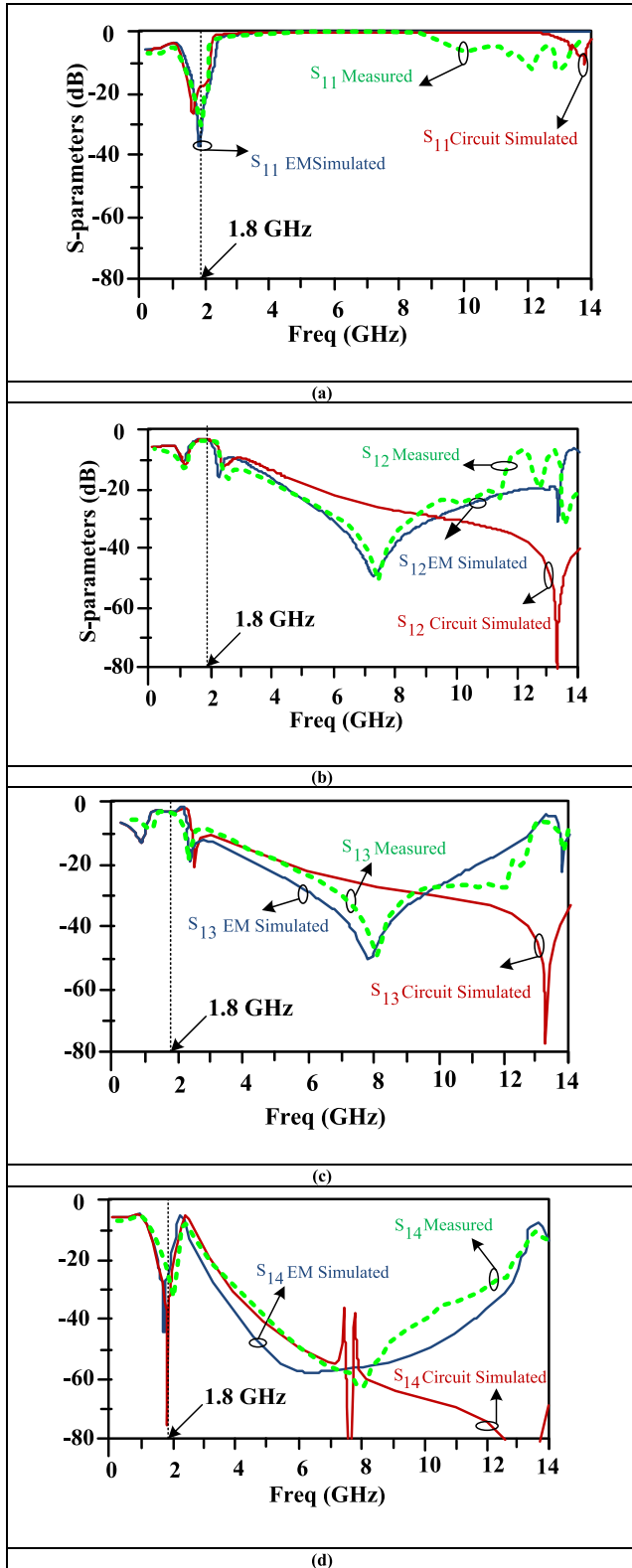

FIGURE 18. The measured and simulated S-parameters of the proposed RRC. (a) S_{11} (b) S_{12} (c) S_{13} (d) S_{14} .

The dimensions of the proposed compact TL not only determine the stop-band bandwidth, but also has a direct effects on the operating bandwidth.

TABLE 3. The performance comparison.

Ref	Device Type	Size Reduction	Harmonic Suppression	Applied Technique
[11]	RRC	55%	2 nd , 3 rd	Resonators
[18]	RRC	54%	3 rd	DGS
[27]	WPD	45%	2 nd -5 th	Resonators
[28]	BLC	39%	-	DGS and PBG
[29]	BLC	40%	-	strip interdigital distributed lines
[30]	BLC	46%	-	distributed lines
[31]	BLC	-	2 nd -4 th	Non uniform lines
[32]	BLC	63%	2 nd , 3 rd	Open stubs
[33]	BLC	64%	3 rd , 5 th	Resonators
[34]	WPD	-	3 rd , 5 th	Open stubs
[35]	WPD	29%	3 rd -6 th	Resonators
[36]	GPD	-	2 nd , 3 rd	Open stubs
[37]	WPD	-	2 nd	SIW
[38]	WPD	-	2 nd	RLC isolation
[39]	WPD	23%	2 nd	Parallel capacitors
[40]	WPD	60%	2 nd -6 th	Coupled lines
[41]	GPD	-	2 nd	Open stubs
[42]	WPD	55%	2 nd -4 th	Resonators
[43]	GPD	66%	2 nd -7 th	Resonators
This work	RRC	74%	2 nd -7 th	Proposed TL

To demonstrate this, the relationship between the FBW and Cs, Is values (extracted lumped component) are depicted in the Figure 12.

Table. 2, shows the size reduction and harmonics suppression of the proposed RRC compared to the normal coupler.

The proposed RRC has a significantly smaller size than the conventional RRC. The layout of the proposed RRC and normal RRC at 1.8 GHz with the same substrate are shown in Fig. 13. The proposed RRC only occupies 26% of the size of the conventional RRC, which offers 74% size reduction, while it has the additive advantage of harmonic suppression.

The output phase difference of the conventional and proposed RRC are depicted in Fig. 14. The results show that the phase differences between output ports of the conventional and proposed coupler at the design frequency of 1.8 GHz are 1.6° and 0.8°, respectively, showing an improvement of this parameter by the proposed coupler.

VI. FABRICATION AND MEASUREMENT

One prototype of the RRC on RT/Duroid substrate ($\epsilon_r = 2.2$ and $H = 20$ mil) was fabricated and shown in Fig. 15.

The S-parameters of the prototype are measured by a two-ports HP 8720D network analyzer, shown in Fig.16.

The measured scattering parameters of the proposed RRC are demonstrated in Fig. 17. A comparison among circuit simulation, EM simulation, and the measurements are shown in Fig. 18. It can be seen from this figure that there is excellent agreement between measured and simulated results over the frequency band; however, some insignificant discrepancies appeared in the higher out-of-band. The results demonstrate that the proposed RRC operates at 1.8 GHz and suppresses harmonics from 2nd up to 7th with good suppression levels.

As measured results show, the prototype RRC has output insertion losses below 0.2 dB ($S_{12} = S_{13} = -3.2$ dB) and input return loss and ports isolation better than 35 dB at the design frequency of 1.8 GHz.

The proposed RRC exhibits superior performance as compared with other related works. In Table 3, some microstrip branch-line couplers (BLCs), rat-race couplers (RRCs), Wilkinson power dividers (WPDs), and Gysel power dividers (GPDs) with harmonics suppression and size reduction are listed. As results show, the proposed RRC offers the smallest size and provides wide stop-band bandwidth, eliminating seven unwanted harmonics.

VII. CONCLUSION

In this paper, a compact RRC capable of harmonic suppression is presented. In this design, the conventional TLs of RRC are replaced by compact and efficient TL to operate at 1.8 GHz. The proposed RRC was fabricated and tested, showing a good performances compared to the other related works. The insertion losses for two output ports are better than 0.2 dB, while an excellent input return loss and port isolation are obtained for the proposed RRC (better than 35 dB). In the proposed RRC six compact proposed TLs are used, which shows more than 74% size reduction and suppresses 2nd-7th harmonics.

REFERENCES

- [1] D. M. Pozar, *Microwave Engineering*. Hoboken, NJ, USA: Wiley, 2009.
- [2] K. W. Eccleston and S. H. M. Ong, "Compact planar microstripline branch-line and rat-race couplers," *IEEE Trans. Microw. Theory Techn.*, vol. 51, no. 10, pp. 2119–2125, Oct. 2003.
- [3] J. Selga, J. Coromina, P. Vélez, A. Fernández-Prieto, J. Bonache, and F. Martín, "Miniaturised and harmonic-suppressed rat-race couplers based on slow-wave transmission lines," *IET Microw., Antennas Propag.*, vol. 13, no. 9, pp. 1293–1299, 2019.
- [4] F. Hosseinkhani and S. Roshani, "A compact branch-line coupler design using low-pass resonators and meandered lines open stubs," *Turkish J. Elect. Eng. Comput. Sci.*, vol. 26, no. 3, pp. 1164–1170, 2018.
- [5] R.-N. Du, Z.-B. Weng, and C. Zhang, "A miniaturized filtering 3-DB branch-line hybrid coupler with wide suppression band," *Prog. Electromagn. Res. Lett.*, vol. 73, pp. 83–89, 2018.
- [6] W. Huang, C. Liu, L. Yan, and K. Huang, "A miniaturized dual-band power divider with harmonic suppression for GSM applications," *J. Electromagn. Waves Appl.*, vol. 24, no. 1, pp. 81–91, 2010.
- [7] P. Rostami and S. Roshani, "A miniaturized dual band Wilkinson power divider using capacitor loaded transmission lines," *AEU - Int. J. Electron. Commun.*, vol. 90, pp. 63–68, Jun. 2018.
- [8] S. Roshani and S. Roshani, "Design of a compact LPF and a miniaturized Wilkinson power divider using aperiodic stubs with harmonic suppression for wireless applications," *Wireless Netw.*, vol. 26, no. 2, pp. 1493–1501, Feb. 2020.
- [9] K.-O. Sun, S.-J. Ho, C.-C. Yen, and D. van der Weide, "A compact branch-line coupler using discontinuous microstrip lines," *IEEE Microw. Wireless Compon. Lett.*, vol. 15, no. 8, pp. 519–520, Aug. 2005.
- [10] Y. Cao, Z. Wang, S.-J. Fang, and Y. Liu, "A miniaturized 3-DB microstrip TRD coupled-line rat-race coupler with harmonics SUPPRESSION," *Prog. Electromagn. Res. C*, vol. 67, pp. 107–116, May 2016.
- [11] J. Gu and X. Sun, "Miniaturization and harmonic suppression rat-race coupler using C-SCMRC resonators with distributive equivalent circuit," *IEEE Microw. Wireless Compon. Lett.*, vol. 15, no. 12, pp. 880–882, Dec. 2005.
- [12] K. Man Shum, Q. Xue, and C. Hou Chan, "A novel microstrip ring hybrid incorporating a PBG cell," *IEEE Microw. Wireless Compon. Lett.*, vol. 11, no. 6, pp. 258–260, Jun. 2001.
- [13] M. (Behdad) Jamshidi, A. Lalbakhsh, B. Mohamadzade, H. Siahkamari, and S. M. H. Mousavi, "A novel neural-based approach for design of microstrip filters," *AEU-Int. J. Electron. Commun.*, vol. 110, Oct. 2019, Art. no. 152847.
- [14] A. Lalbakhsh, M. (Behdad) Jamshidi, H. Siahkamari, A. Ghaderi, A. Golestanifar, R. Linhart, J. Talla, R. B. V. B. Simorangkir, and K. Mandal, "A compact lowpass filter for satellite communication systems based on transfer function analysis," *AEU-Int. J. Electron. Commun.*, vol. 124, Sep. 2020, Art. no. 153318.
- [15] A. Lalbakhsh, S. M. Alizadeh, A. Ghaderi, A. Golestanifar, B. Mohamadzade, M. Jamshidi, K. Mandal, and W. Mohyuddin, "A design of a dual-band bandpass filter based on modal analysis for modern communication systems," *Electronics*, vol. 9, no. 11, p. 1770, Oct. 2020.
- [16] A. Lalbakhsh, M. U. Afzal, K. P. Esselle, and S. L. Smith, "A high-gain wideband EBG resonator antenna for 60 GHz unlicensed frequency band," in *Proc. 12th Eur. Conf. Antennas Propag. (EuCAP)*, 2018, pp. 1–3.
- [17] A. Lalbakhsh, A. Ghaderi, W. Mohyuddin, R. B. V. B. Simorangkir, N. Bayat-Makou, M. S. Ahmad, G. H. Lee, and K. W. Kim, "A compact C-Band bandpass filter with an adjustable dual-band suitable for satellite communication systems," *Electronics*, vol. 9, no. 7, p. 1088, Jul. 2020.
- [18] Y. J. Sung, C. S. Ahn, and Y.-S. Kim, "Size reduction and harmonic suppression of rat-race hybrid coupler using defected ground structure," *IEEE Microw. Wireless Compon. Lett.*, vol. 14, no. 1, pp. 7–9, Jan. 2004.
- [19] S. Opozda, P. Kurgan, and M. Kitlinski, "A compact seven-section rat-race hybrid coupler incorporating PBG cells," *Microw. Opt. Technol. Lett.*, vol. 51, no. 12, pp. 2910–2913, Dec. 2009.
- [20] M. Heydari and S. Roshani, "Miniaturised unequal Wilkinson power divider using lumped component elements," *Electron. Lett.*, vol. 53, no. 16, pp. 1117–1119, Aug. 2017.
- [21] M. B. Jamshidi, S. Roshani, J. Talla, S. Roshani, and Z. Peroutka, "Size reduction and performance improvement of a microstrip Wilkinson power divider using a hybrid design technique," *Sci. Rep.*, vol. 11, no. 1, pp. 1–15, Dec. 2021.
- [22] M. Amir Sattari, G. Hossein Roshani, R. Hanus, and E. Nazemi, "Applicability of time-domain feature extraction methods and artificial intelligence in two-phase flow meters based on gamma-ray absorption technique," *Measurement*, vol. 168, Jan. 2021, Art. no. 108474, doi: 10.1016/j.measurement.2020.108474.
- [23] G. H. Roshani, R. Hanus, A. Khazaei, M. Zych, E. Nazemi, and V. Mosorov, "Density and velocity determination for single-phase flow based on radiotracer technique and neural networks," *Flow Meas. Instrum.*, vol. 61, pp. 9–14, Jun. 2018, doi: 10.1016/j.flowmeasinst.2018.03.006.
- [24] A. Karami, G. H. Roshani, A. Khazaei, E. Nazemi, and M. Fallahi, "Investigation of different sources in order to optimize the nuclear metering system of gas-oil-water annular flows," *Neural Comput. Appl.*, vol. 32, pp. 3619–3631, Aug. 2018, doi: 10.1007/s00521-018-3673-0.
- [25] A. Karami, G. H. Roshani, E. Nazemi, and S. Roshani, "Enhancing the performance of a dual-energy gamma ray based three-phase flow meter with the help of grey wolf optimization algorithm," *Flow Meas. Instrum.*, vol. 64, pp. 164–172, Dec. 2018.
- [26] E. Nazemi, G. H. Roshani, S. A. H. Feghhi, S. Setayeshi, E. Eftekhari Zadeh, and A. Fatehi, "Optimization of a method for identifying the flow regime and measuring void fraction in a broad beam gamma-ray attenuation technique," *Int. J. Hydrogen Energy*, vol. 41, no. 18, pp. 7438–7444, May 2016.
- [27] M. Jamshidi, A. Lalbakhsh, S. Lotfi, H. Siahkamari, B. Mohamadzade, and J. Jalilian, "A neuro-based approach to designing a Wilkinson power divider," *Int. J. RF Microw. Comput.-Aided Eng.*, vol. 30, no. 3, Mar. 2020, Art. no. e22091.
- [28] P. Kurgan and M. Kitliński, "Novel doubly perforated broadband microstrip branch-line couplers," *Microw. Opt. Technol. Lett.*, vol. 51, no. 9, pp. 2149–2152, Sep. 2009.
- [29] Y. B. Jung, "Wideband branchline coupler using symmetrical four-strip interdigitated coupler," *Electron. Lett.*, vol. 50, no. 6, pp. 452–454, 2014.
- [30] Y.-H. Chun and J.-S. Hong, "Compact wide-band branch-line hybrids," *IEEE Trans. Microw. Theory Techn.*, vol. 54, no. 2, pp. 704–709, Feb. 2006.
- [31] K. A. Alshamaileh, V. K. Devabhaktuni, and N. I. Dib, "Impedance-varying broadband 90° branch-line coupler with arbitrary coupling levels and higher order harmonic suppression," *IEEE Trans. Compon., Packag., Manuf. Technol.*, vol. 5, no. 10, pp. 1507–1515, Oct. 2015.
- [32] J.-S. Kim and K.-B. Kong, "Compact branch-line coupler for harmonic suppression," *Prog. Electromagn. Res. C*, vol. 16, pp. 233–239, Jul. 2010.

- [33] S. Roshani and S. Roshani, "A compact coupler design using meandered line compact microstrip resonant cell (MLCMRC) and bended lines," *Wireless Netw.*, vol. 27, no. 1, pp. 677–684, Jan. 2021.
- [34] M. Hayati and S. Roshani, "A novel Wilkinson power divider using open stubs for the suppression of harmonics," *ACES J.*, vol. 28, no. 6, pp. 501–505, 2013.
- [35] M. Hayati, S. Roshani, and S. Roshani, "Miniaturized Wilkinson power divider with nth harmonic suppression using front coupled tapered CMRC," *ACES J.*, vol. 28, no. 3, pp. 221–227, 2013.
- [36] E. Moradi, A.-R. Moznebi, K. Afrooz, and M. Movahhedi, "Gysel power divider with efficient second and third harmonic suppression using one resistor," *AEU-Int. J. Electron. Commun.*, vol. 89, pp. 116–122, May 2018.
- [37] K. Song, Y. Zhu, and F. Zhang, "Single-and dual-band filtering-response power dividers embedded SIW filter with improved output isolation," *Sci. Rep.*, vol. 7, no. 1, p. 3361, 2017.
- [38] S. Chao and Y. Li, "Miniature filtering power divider with increased isolation bandwidth," *Electron. Lett.*, vol. 50, no. 8, pp. 608–610, Apr. 2014.
- [39] A. Chen, Y. Zhuang, J. Zhou, Y. Huang, and L. Xing, "Design of a broadband Wilkinson power divider with wide range tunable bandwidths by adding a pair of capacitors," *IEEE Trans. Circuits Syst. II, Exp. Briefs*, vol. 66, no. 4, pp. 567–571, Apr. 2019.
- [40] K. Song, S. Hu, F. Zhang, Y. Zhu, and Y. Fan, "Compact dual-band filtering-response power divider with high in-band frequency selectivity," *Microelectron. J.*, vol. 69, pp. 73–76, Nov. 2017.
- [41] F.-X. Liu, Y. Wang, X.-Y. Zhang, C.-H. Quan, and J.-C. Lee, "A size-reduced tri-band Gysel power divider with ultra-wideband harmonics suppression performance," *IEEE Access*, vol. 6, pp. 34198–34205, 2018.
- [42] S. Roshani, M. B. Jamshidi, F. Mohebi, and S. Roshani, "Design and modeling of a compact power divider with squared resonators using artificial intelligence," *Wireless Pers. Commun.*, vol. 117, no. 3, pp. 2085–2096, Apr. 2021.
- [43] M. Jamshidi, H. Siahkamari, S. Roshani, and S. Roshani, "A compact Gysel power divider design using U-shaped and T-shaped resonators with harmonics suppression," *Electromagnetics*, vol. 39, no. 7, pp. 491–504, Oct. 2019.



GOLSHAN MOHAMADPOUR received the B.Sc. degree in electrical engineering from Razi University, Kermanshah, Iran, in 2016, and the Master of Research degree in electronics engineering from Shahid Beheshti University, Tehran, Iran, in 2019. Her research interests include the low-power and low-size integrated circuit design, and microwave and millimeter wave devices and circuits.



SAEED ROSHANI (Member, IEEE) received the B.Sc. degree in electrical engineering from Razi University, Kermanshah, Iran, in 2008, the M.Sc. degree in electrical engineering from Shahed University, Tehran, Iran, in 2011, and the Ph.D. degree in electrical engineering from Razi University, in 2015. He is currently an Associate Professor with the Department of Electrical Engineering, Islamic Azad University, Kermanshah. He performed opportunity research program with Amirkabir University of Technology (Tehran Polytechnics), Iran, from 2014 to 2015. He graduated as the best student of his country among all students of Iran, in 2015, and awarded by the First Vice President and Science, Research and Technology Minister. He has published more than 70 papers in ISI journals and conferences. His research interests include the microwave and millimeter wave devices and circuits and low-power and low-size integrated circuit design.



ALI LALBAKSH (Member, IEEE) received the B.S. and M.S. degrees in electronic and telecommunication engineering, in 2008 and 2011, respectively, and the Master of Research (H.D.) and Ph.D. degrees in electronics engineering from Macquarie University, Australia, in 2015 and 2020, respectively. He currently holds an academic position (Macquarie University Research Fellowship) with Macquarie University. He has published over 80 peer-reviewed journal articles and conference papers. His research interests include satellite communication, high-gain antennas, evolutionary optimization methods, and passive microwave components. He received several prestigious awards, including the International Research Training Program Scholarship (iRTP) for the MRes, the International Macquarie University Research Excellence Scholarship (iMQRES) for the Ph.D. degree, the Commonwealth Scientific and Industrial Research Organization (CSIRO) grants on Astronomy and Space Exploration, the Macquarie University Postgraduate Research Fund (PGRF), and the WiMed Travel Support Grants. He was a recipient of the 2016 ICEAA-IEEE APWC Cash Prize and the Macquarie University Deputy Vice-Chancellor Commendation in 2017. He is the only Researcher in the IEEE Region Ten (Asia-Pacific) who received the Most Prestigious Best Paper Contest of the IEEE Region Ten more than once. He was awarded Third Prize in 2016, First Prize in 2018, and Second Prize in 2019 from the International Competition. He is the highly commended finalist and the winner of the Excellence in Higher Degree Research Award in Science, Technology, Engineering, Mathematics and Medicine (STEMM), Macquarie University, in 2019 and 2020, respectively. In 2020, he was announced as an Outstanding Reviewer of IEEE TRANSACTIONS ON ANTENNAS AND PROPAGATION and received the Research Excellence Award of the Faculty of Science and Engineering, Macquarie University. He serves as an Associate Editor for the *AEÜ-International Journal of Electronics and Communications*, and *Electronics (MDPI)*.



MOHAMMAD AMI received the B.Sc. and M.Sc. degrees in electrical engineering from Islamic Azad University, Kermanshah Branch, Kermanshah, Iran, in 2017 and 2020, respectively. His research interests include the low-power and low-size integrated circuit design, microwave circuits, power dividers, couplers, filters, and diplexers.



SOBHAN ROSHANI received the B.Sc. degree in electrical engineering from Razi University, Kermanshah, Iran, in 2010, the M.Sc. degree in electrical engineering from Iran University of Science and Technology (IUST), Tehran, Iran, in 2012, and the Ph.D. degree in electrical engineering from Razi University, in 2016. He is currently an Assistant Professor with the Department of Electrical Engineering, Kermanshah Branch, Islamic Azad University, Kermanshah. He has published more than 70 papers on international journals and conferences. His research interests include switching power amplifiers, optimization and neural networks, artificial intelligence, modeling, microwave circuits, power dividers, couplers, filters, and diplexers.



ABU SADAT MD. SAYEM received the B.Sc. degree (Hons.) in electrical and electronic engineering from Rajshahi University of Engineering and Technology, Bangladesh, in 2011, the M.Sc. degree in electrical and electronic engineering from Rajshahi University of Engineering and Technology, in 2015, and the Ph.D. degree in electronic engineering (with the Vice-Chancellor's Commendation for Academic Excellence) from Macquarie University, Australia, in

2021. He worked as an Assistant Professor with the Department of Electrical and Electronic Engineering, Rajshahi University of Engineering and Technology, from 2015 to 2017, and a Lecturer with the Department of Electrical and Electronic Engineering, from 2012 to 2015. His current research interests include wearable antennas, flexible antennas, transparent antennas, and antennas for biomedical applications. He regularly reviews papers for leading journals in his research field. He was a recipient of several prestigious awards and scholarships, including the Vice-Chancellor's Commendation on Ph.D. thesis, the Commonwealth Government funded International Research Training Program Scholarship to support the Ph.D. in Australia, the Prime Minister Gold Medal from Bangladesh, and the University Gold Medal from Rajshahi University of Engineering and Technology.



MOHAMMAD ALIBAKHSHKENARI (Member, IEEE) was born in Mazandaran, Iran, in February 1988. He received the Ph.D. degree (Hons.) in electronic engineering from the University of Rome "Tor Vergata," in February 2020. He was a Ph.D. Visiting Researcher with the Chalmers University of Technology, in 2018. His training during the Ph.D. included a research stage in the Swedish company Gap Waves AB. He is currently with the Department of Signal

Theory and Communications, Universidad Carlos III de Madrid, as a Principal Investigator of the CONEX-Plus Talent Training Program and Marie Skłodowska-Curie Actions. His research interests include antennas and wave-propagations, metamaterials and metasurfaces, synthetic aperture radars (SAR), multiple-input multiple-output (MIMO) systems, substrate integrated waveguides (SIWs), impedance matching circuits, microwave components, millimeter-waves and terahertz integrated circuits, and electromagnetic systems. The above research lines have produced more than

120 publications on international journals, presentations within international conferences, and book chapters with a total number of the citations more than 1900 and H-index of 33. He was recipient of (i) three years research grant funded by the Universidad Carlos III de Madrid and the European Union's Horizon 2020 Research and Innovation Program under the Marie Skłodowska-Curie Grant 801538 started in July 2021, (ii) two years research grant funded by the University of Rome "Tor Vergata" started in November 2019, and (iii) three years Ph.D. Scholarship funded by the University of started in November 2016. He was a recipient of two Young Engineer Awards of the 47th and 48th European Microwave Conference held in Nuremberg, Germany, in 2017, and in Madrid, Spain, in 2018, respectively. He is serving as an Associate Editor for *IET Journal of Engineering* and *International Journal of Antennas and Propagation*. He also acts as a referee in several highly reputed journals and international conferences. His research article entitled "High-Gain Metasurface in Polyimide On-Chip Antenna Based on CRLH-TL for Sub Terahertz Integrated Circuits" published in *Scientific Reports* was awarded as the Best Month Paper at the University of Bradford, in April 2020.

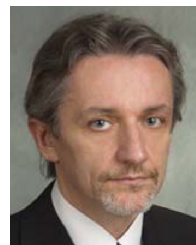

SLAWOMIR KOZIEL (Senior Member, IEEE) received the M.Sc. and Ph.D. degrees in electronic engineering from Gdańsk University of Technology, Poland, in 1995 and 2000, respectively, and the M.Sc. degree in theoretical physics, the M.Sc. degree in mathematics, and the Ph.D. degree in mathematics from the University of Gdańsk, Poland, in 2000, 2002, and 2003, respectively. He is currently a Professor with the Department of Engineering, Reykjavik University, Iceland.

His research interests include CAD and modeling of microwave and antenna structures, simulation-driven design, surrogate-based optimization, space mapping, circuit theory, analog signal processing, and evolutionary computation and numerical analysis.

...