

TEST METHOD FOR DETERMINING THE CHEMICAL EMISSIONS OF A MARINE DIESEL ENGINE EXHAUST IN OPERATION

Zbigniew Korczewski

Gdańsk University of Technology, Poland

* Corresponding author: z.korczewski@gmail.com

ABSTRACT

The article briefly describes the problem of air pollution caused by sea-going ships and the resulting restrictions on the emission of toxic and harmful chemical compounds in the exhaust of marine engines, introduced by the International Maritime Organization (IMO) under the International Convention for the Prevention of Sea Pollution from Ships (MARPOL 73/78). Such emissions provide a significant metrological problem, not only for the owners of operating sea-going ships, but also for shipyards, maritime administration offices and environmental protection inspectors. For this reason, the article's author is developing research issues related to the diagnosing the exhaust emissions of marine engines under operating conditions, i.e. with limited control (measurement) susceptibility. This is particularly important in the period of intensive implementation of a new category of marine fuel, so-called modified fuels with low sulphur content. As part of the problem, a computational model of the parameters characterising the exhaust emissions of a marine engine in operation is presented in this article. This model is based on the measurement of the engine's control parameters, using a standard (stationary) measurement system and a portable diagnostic system, configured for the purpose of this research. Presented here are representative measurements and calculation results (both obtained by the author and provided by the manufacturer) from the chemical exhaust gas emissivity of one of the ship engines operated. These confirm the adequacy of the calculation model developed and the diagnostic effectiveness of the measuring equipment applied. The methodology developed for experimental testing may also be implemented for the operation of other types of marine engines, provided that the basic chemical composition of the fuel supply and the engine load characteristics and hourly fuel consumption are known. Moreover, there is the possibility of indicating the cylinders and measuring the chemical composition of exhaust gases in the high-temperature part of the exhaust duct.

Keywords: marine engine, exhaust chemical emissions, diagnostic tests in operation

INTRODUCTION

Air pollution due to combustion engines currently poses one of the greatest threats to the Earth's natural environment. Observable symptoms of this progressive degradation include more violent and frequent weather anomalies, long term climate alterations and the dramatically increasing incidence of various types of neoplastic diseases. Taking into account the fact that there are over 200,000 passenger flights per year, the seas and oceans support 100,000 ships and the

number of cars will reach 1.5 billion by 2025,¹ it is possible to approximate the total emission of engine exhaust gases into the atmosphere for each branch of the world's transport. The biggest environmental problem today is the emission of poisonous gases and particulates in the exhaust of marine engines, fed by the lowest-quality fuels. For example, only one in eight of the largest container ships in the world (the Mærsk E-class type, which burns 16.7 tons of residual fuel per hour

¹ The data presented do not take into account the current period of the coronavirus pandemic.

with a nominal load of about 400 tons per day) can emit the same amount of pollutants into the atmosphere (per year) as 50 million cars [1, 12] and this is only the proverbial 'tip of the iceberg'. For this reason and on the initiative of the Marine Environment Protection Committee of the International Maritime Organization (IMO), further amendments to MARPOL 73/78 have been introduced, which increasingly restrict the permissible standards of the weighted average unit emission of nitrogen oxides (NO_x) and sulphur oxides (SO_x) in marine engine exhaust gases, determined in g/kW·h [22]. This is in addition to the schedule of their implementation in the navigation of ships operating in international waters as well as NO_x and SO_x emission control areas, which are much more stringent [10].

Since 1 January 2013, the emission of carbon dioxide (CO_2) in engine exhaust gases has also been indirectly reduced by defining and implementing the Energy Efficiency Design Index (EEDI) for all new-build ships and the Energy Efficiency Operational Indicator (EEOI) for existing ships [14, 17, 18, 20, 23]. One of the parameters of the latter indicator is the carbon dioxide emission factor, expressed as the ratio of the mass of CO_2 emitted to the mass of fuel burnt.

As the ecological situation of the natural environment is constantly changing for the worse, adequate preventive measures, including technological and legislative control measures, are necessary. Both the producers of marine fuels and marine engines, especially shipowners (operators), have little time to adapt to these measures. It is true that new, improved design solutions for engine exhaust gas cleaning systems (wet 'scrubber' or dry 'sorber' type) are appearing in the shipbuilding market. So-called modified, low-emission marine fuels and gaseous fuels, which are intended at ecologically revolutionising the traditional engine propulsion of sea-going ships, are also appearing. However, it takes many years to positively verify their operational suitability, not only in terms of energy and structural reliability, but also in terms of the chemical emission aspects of the marine engines fed by them.

Thus, at present the basic operational problem is monitoring the amount and chemical composition of the exhaust gases emitted by practically every marine engine with a power above 130 kW installed on a ship built or modernised since 1 January 2000, under operating conditions. This issue does not represent a major metrological difficulty in the case of the chemical emission measurements of exhaust gases, carried out as part of the engine manufacturer's test bed tests. Such test results are usually included in the delivery and acceptance documentation [21]. Specialised research centres have also been equipped with full-size, high-power diesel engines (above 1 MW), in order to undertake research into the emission of toxic and harmful exhaust components of new types of marine fuel [22], or the impact of these emissions on known and recognisable engine damage [9]. However, the question remains as to how to deal with the implementation of this type of research, in relation to a series engine with low control compliance, built within a ship engine room and equipped only with standard control and measurement units

to ensure its correct use, without the possibility of precisely diagnosing the working process. How do we overcome the successive metrological limitations resulting from dynamic sailing conditions and the need to maintain the desired parameters of the ship's movement (course and speed) during the measurements, which translate into frequent and significant changes in the load of the tested engines? In this regard, it is difficult and even impossible to comply with all of the IMO's metrological requirements, as described in ISO 8178 'Reciprocating Internal Combustion Engines – Exhaust Emission Measurements', when assessing marine engine exhaust emissions under the real operating conditions of marine engines. This is a significant research gap, there being a marked lack of scientific publications on this topic.

For the reasons given above, this article proposes a significantly simplified engineering approach to the issue of making operational measurements of the quantity and chemical composition of marine engine exhaust emissions. A methodology for the implementation of this type of engine research was developed with the application of appropriately configured measuring equipment and was verified during the cyclical diagnosis of the ship main propulsion engines currently in operation.

Thus, the main aim of this article is to verify the elaborated calculation model of marine engine exhaust emissions by means of comparing the manufacturer's results with their own at the same values of input parameters. The article's second objective is to identify the effect of a high-power, four-stroke marine diesel engine fed with low-sulphur marine fuel (RMD 80 type) on the combustion and emission of gaseous components in the exhaust. This paper presents the results of such examinations carried out in operating conditions.

The RMD 80 fuel implemented had previously been tested by the author in terms of its energy, emission and reliability consequences on a specifically designed diesel engine test bed built on a small scale. The positive results of the laboratory tests confirmed its suitability for powering full-size marine engines [7, 8].

RESEARCH METHODOLOGY AND APPLIED MEASURING APPARATUS

A MAN Diesel 10L32/44CR engine was selected to evaluate the exhaust's chemical emission in operating conditions. This is a large, four-stroke, medium-speed, common rail, electronic fuel injection marine diesel engine that is widely used by fleets across the world. A general view of such an engine installed in a ship's engine room is shown in Fig. 1. Table 1 summarises the values of the basic parameters using an example copy of the marine engine type considered, recorded during tests with the manufacturer's dynamometer. In the experiment, the engine operating conditions were controlled and their related parameters were monitored by means of the ship's standard measurement system as well as a portable diagnostic system (Fig. 1).

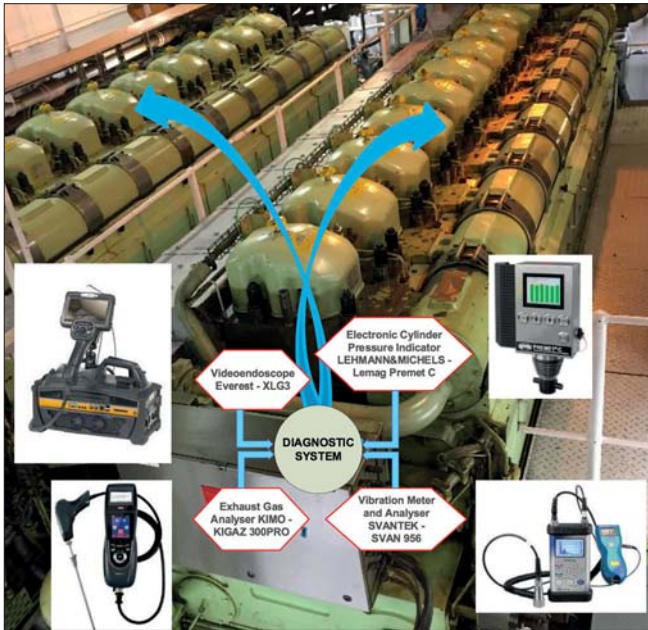

Fig. 1. General view of MAN Diesel 10L32/44CR engines installed in a marine power plant, along with a portable diagnostic system applied to exhaust emission operational tests

Tab. 1. Examples of basic parameters of a MAN Diesel 10L32/44CR engine

No.	Engine load	$P_i/n_{CS}/n_{TC}$	\dot{m}_{fuel}	SFOC
		$\text{kW}/\text{min}^{-1}/\text{min}^{-1}$		
1	nominal	5588/749/23440	1,041	186.3
2	0.75 nom.	4201/750/21080	795	189.2
3	0.51 nom.	2828/750/17980	555	196.3
4	0.25 nom.	1402/750/12070	299	213.3

The operational testing method for marine engine exhaust emissions is based on the calculation model (Fig. 2), in which the input parameters are represented by the engine's basic parameters (indicated power P_i and total fuel mass flow \dot{m}_{fuel}) as well as the engine control parameters determined from the measurement of the exhaust gas composition. These parameters include the excess air coefficient λ and the volumetric fractions r of the following chemical compounds in the exhaust gas: CO_2 , CO , NO_x , SO_x and HC . Unit emissions e of the basic toxic and harmful gases in the engine exhaust (expressed in $\text{g}/\text{kW}\cdot\text{h}$) and their weighted average \bar{e} were determined in relation to the assumed engine load distribution. $W_{\%}$ stands for the output values of the model. The approximate chemical composition of the fuel, determined by the mass fractions of carbon C, hydrogen H, sulphur S, nitrogen N and oxygen O as a ballast as well as the crankshaft rotational speed n_{CS} and mechanical efficiency η_m of a given engine type at a given indicated power P_i represent the constant values of the model.

A detailed algorithm for the implementation of individual calculation procedures is presented in Fig. 3.

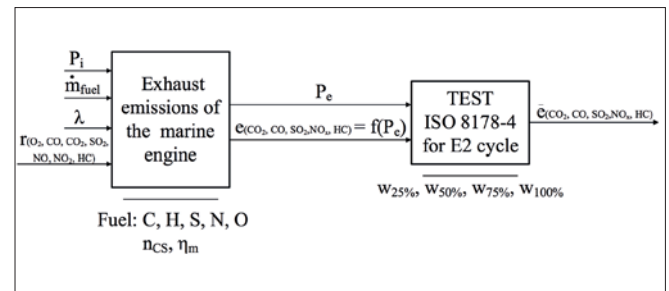

Fig. 2. Calculation model of exhaust emissions of a marine engine in operation

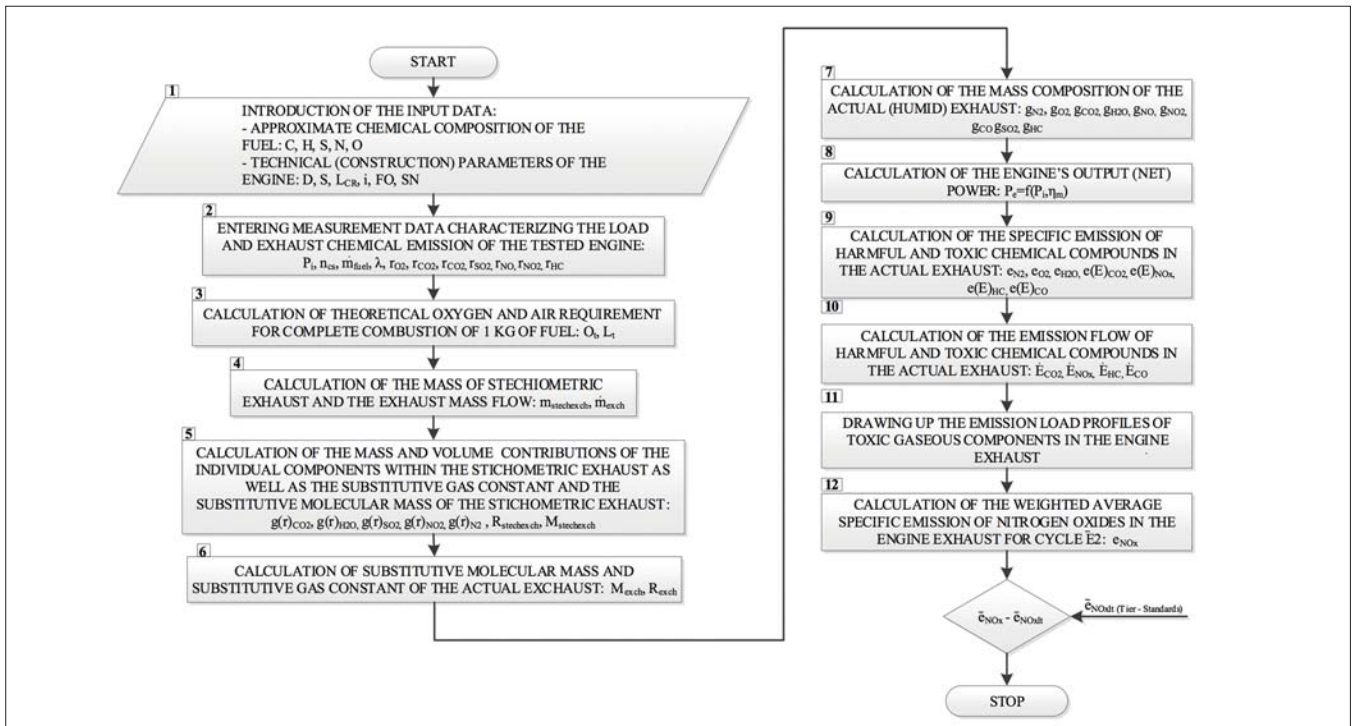

Fig. 3. Calculation block algorithm for determining the load characteristics of the chemical emissions in the marine engine's exhaust

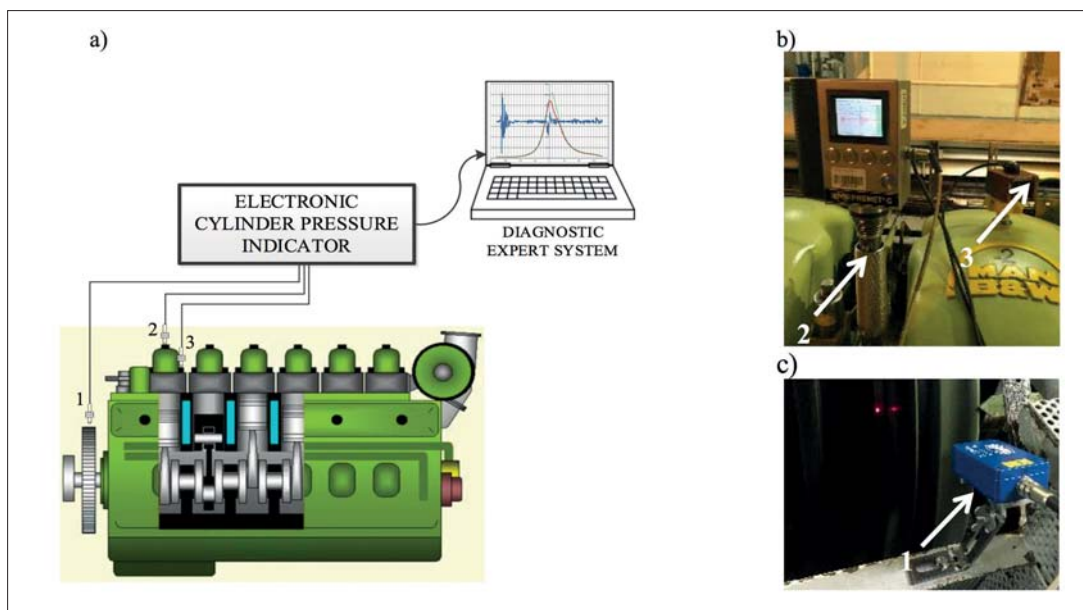

Fig. 4. Elements of the system diagnosing the working spaces of a marine engine by means of an electronic cylinder pressure indicator: a) schematic diagram; b) method of mounting the electronic indicator of the LEMAG PREMET C type (along with a pressure transducer) on the indicator cock and the vibration acceleration transducer on the nut fixing the head cover (from the inlet valve side); c) method of mounting the laser sensor of the rotational speed of the engine output's shaft. 1 – angular position sensor of the crankshaft; 2 – cylinder pressure sensor; 3 – vibration acceleration converter [6]

The key metrological issue in the proposed method of determining the exhaust emissions of the ship's main propulsion engine under ship conditions, according to the developed calculation model, is the precise determination of the engine's effective power P_e in representative steady-load conditions. The engine load distribution results from the accepted E2 or E3 test are described in the ISO 8178-4 standard recommended by the IMO. In the case of the considered ship's main propulsion engine type, it operates at a constant crankshaft rotational speed of 750 min^{-1} driving the set screw; according to the E2 test, the distribution of the applied loads is closer to its actual operating conditions.

There are two methods of determining the effective power in the operation of the main propulsion engines:

- on the basis of the results of the simultaneous measurement of the torque and the rotational speed of the engine's output shaft by means of torque meters, in which the on-line measurements of the torsion angle of the propeller shaft section are as close as possible to the engine flywheel and are used for the calculations;
- on the basis of the results of the simultaneous measurement of the cylinder pressures and the rotational speeds of the engine crankshaft by means of electronic indicators. This makes it possible to determine the indicated engine power P_i (internal, gas dynamic) which, reduced by the so-called power of mechanical losses P_m ,² gives the required effective (net) power P_e . The above methods have their limitations, both in terms of the diagnostic susceptibility of the tested engine and the widely understood measurement uncertainty.

² These result from the frictional resistance of the engine's moving parts (depending on the relative speeds, pressure forces, pressure and viscosity of the lubricating oil and the engine's technical condition), pumping resistance (which concerns four-stroke engines) and power losses on the auxiliary mechanisms connected to the engine crankshaft.

In the case of determining the effective engine power on the basis of the torque measurements of the motor's output shaft, two possible procedures are conducted. The first, the so-called indirect procedure, consists of the application of foil strain gauges, glued to the shaft surface and soldered into a measuring bridge, enabling the shaft torsion angle to be determined and the transferred torque to be calculated. It is necessary to know the shear modulus of the material composing the propulsion shaft. The second procedure is the so-called direct procedure and is more commonly introduced into marine propulsion operations. It consists of mounting a measuring section on the ship's propulsion line, along with an appropriately calibrated torque converter, usually of the laser type. It is easy to assemble, disassemble, replace and recalibrate. The result of the torque measurement is read directly in $N \cdot m$. In both the first and the second approaches to the problem of determining the effective engine power from the torque measurements, the low diagnostic susceptibility of the tested objects presents a significant metrological difficulty. Most often, the mechanical power of the entire drive unit is determined by mounting the measuring transducers on the propeller shaft, i.e. in the control section of the drive line, far away from the engine flywheel. In such a situation, in order to determine its effective power, one should take into account the mechanical losses caused by the friction of the moving parts of the shaft line installed between the engine and the place where the torque and the rotational speed are measured, i.e. the reduction gear, couplings, bearings and possibly the attached auxiliary mechanisms, e.g. shaft generators.

A much simpler and more accurate method of determining the effective power of a marine engine in operation is the appropriate usage of the data transmitted from the electronic cylinder pressure indicator, see Fig. 4 [11, 15]. The control parameters of the turbocharger should also be taken into account [6, 16].

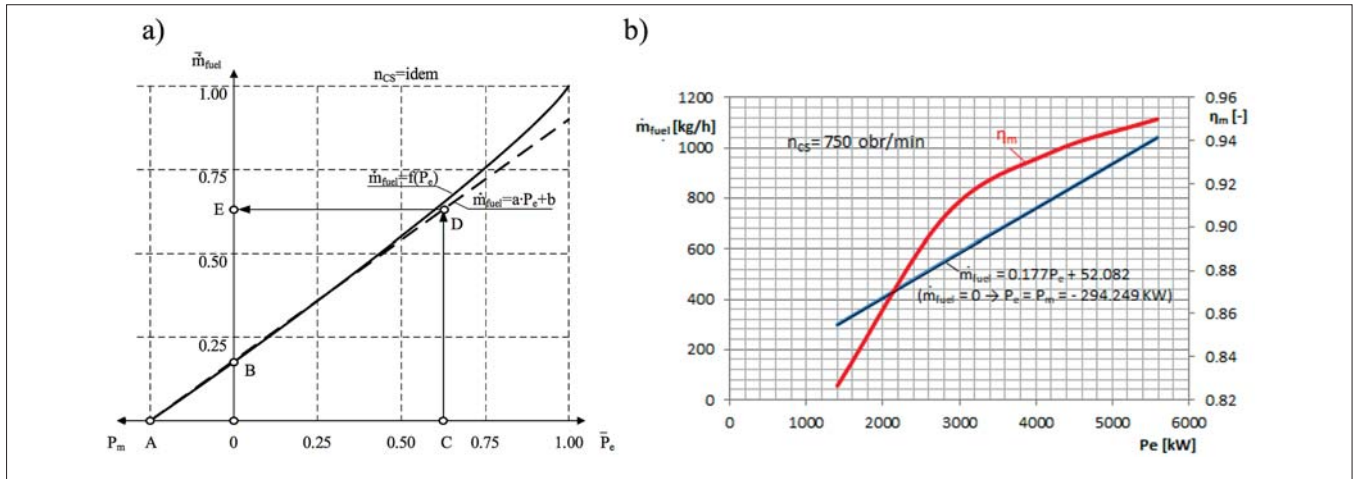

Fig. 5. The method of determining the mechanical efficiency from the load characteristics of a diesel engine running at a constant rotational speed of the crankshaft: a) theoretical characteristics; b) real characteristics

The main purpose of this type of diagnostic test, carried out on piston engines, is to assess the indicated power P_i as well as the tightness and the load uniformity of individual cylinders, based on the registration and analysis of developed indicator diagrams [4, 6]. However, along with the additional load characteristics of the mechanical efficiency of the tested engine η_m prepared for the adjusted (steady) rotational speed of the crankshaft $n_{cs} = idem$, it is possible to estimate, to a certain approximation, its effective power: $P_e = P_i \cdot \eta_m$. The influence of the pressure and viscosity of the lubricating oil and the technical condition of the engine are ignored. In order to determine the mechanical efficiency of the engine, the results of the calculations of the effective power P_e and the total mass flow of the applied fuel feed \dot{m}_{fuel} should be considered. These data are acquired on the basis of the measurement of the control parameters recorded during engine shop tests in the manufacturer's dynamometer test bed (Table 1). They are always attached to the technical documentation handed over to the shipowner along with the engine. The results obtained in this way, as a dependency $\dot{m}_{fuel} = a \cdot P_e + b$, are approximated by the linear function. The assigned curve is then extrapolated to the intersection with the axis of abscissa (point A in Fig. 5a). This is a characteristic feature of piston engines running at a constant rotational speed of the crankshaft over a wide range of partial loads (up to about 80–90% P_{nom}).

If a running engine is generating no power, which means that its effective power is equal to zero, it still consumes a certain amount of fuel (section 0B), which is used to overcome internal resistance. Hence, from the straight line equation $\dot{m}_{fuel} = a \cdot P_e + b$ for each engine load P_e , its mechanical efficiency η_m can be determined in a simplified manner, as the ratio of the lengths of sections 0C/AC. An example of the application of this method (the so-called Willans method)³ to determine the load characteristics of the mechanical efficiency of the

MAN Diesel 10L32/44CR marine engine powered by MDO/DMC – ISO 8217 distillate fuel is shown in Fig. 5b.

The fuel feed mass flow \dot{m}_{fuel} represents another input parameter of the proposed marine engine exhaust emission model. The most commonly used method of measurement in operational conditions consists of the application of a precise flow meter, installed in the fuel feed system between the service and return tanks. In this way, the fuel recovered from the injection pump overflows is taken into account. In the present study, in order to measure the fuel consumption of the main propulsion engines of the considered ship, Emerson Coriolis mass flow meters, type 1700 (Micro Motion Coriolis MVD single variable flow transmitter), installed directly in front of the return tank ('MIX TANK'), were used (Figs. 6 and 7). The red arrows in Fig. 6 show the ship's main engines (ME1... ME4) as well as the measurement points of fuel feed consumption (ME HFO USE). A homogeneous system was used to drive the ship, in which the basic variant of sailing is carried out by the autonomous operation of one of the two engines of the left and right drive units. Therefore, the usage of only one flow meter for each drive unit is perfectly justified.

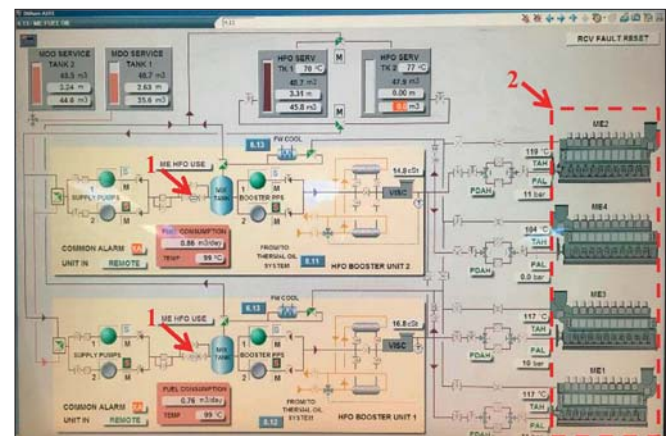

Fig. 6. Operator panel (visualisation) presenting the basic control parameters of the fuel feed system of the ship's main engines: 1 – fuel consumption measurement points, 2 – main engines

³ Peter William Willans (1851–1892) was an English engineer, constructor of steam engines and author of many patents relating to high-speed piston engines. He was the first to apply the extrapolation method within the function of steam consumption in terms of engine load to determine internal losses due to steam condensation and leakages.

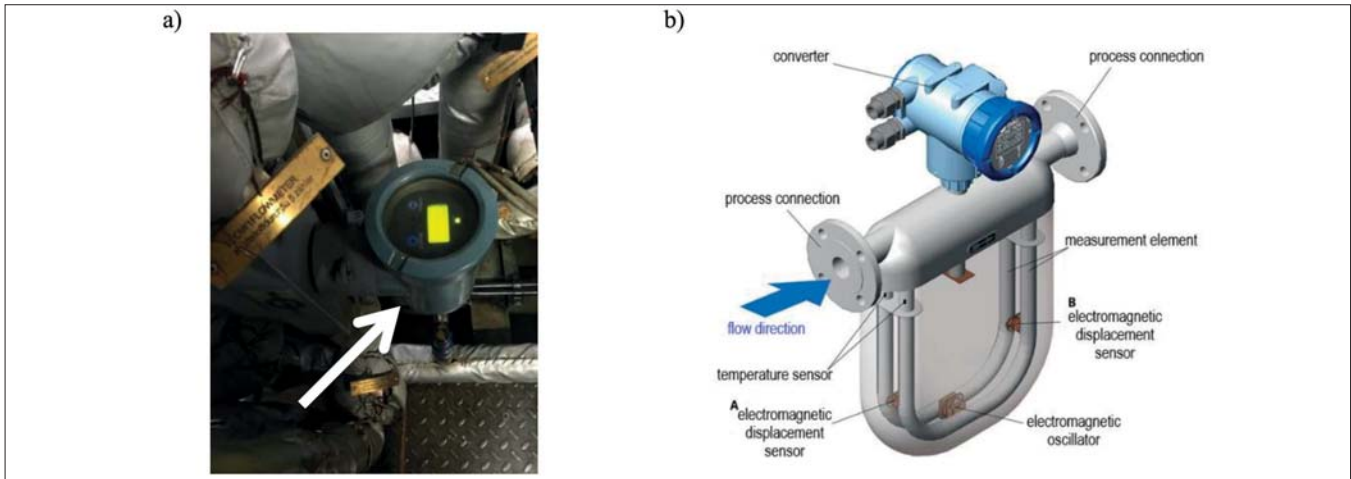

Fig. 7. Emerson Coriolis mass flow meters, type 1700: a) method of mounting the flow meter on the engine's fuel feed system; b) arrangement of oscillating pipes in the flow meter [2]

The implemented Emerson flow meters enable the simultaneous observation of the mass flow, density and temperature of the engine feed fuel. The principle of the flow meter's performance is based on the phenomenon of generating Coriolis forces in the system of counter-oscillating U-shaped sections of the pipeline through which the fluid flows, either compressible or incompressible, see Fig. 7b [2]. A certain degree of inertia occurs in the flow, resulting in a delay of the vibration phase in the inlet part of the measuring section of the pipeline and its acceleration in the outlet part. The phase shift of the recorded vibration signals indicates a measure of the mass flux of the flowing fluid, while the resonance frequency indicates its density. The fuel temperature is determined indirectly from the temperature measurements of the measuring pipes. The fuel temperature is necessary for introducing appropriate compensation corrections in the flowmeter measuring system. The accuracy of the Emerson 1700 Coriolis mass flow meter is as follows:

- fuel mass flux: $\pm 0.1\%$
- fuel density: $\pm 1 \text{ kg/m}^3$
- fuel temperature: $\pm 0.1^\circ\text{C}$

The longer the flow meter is used, the more accurate its flow consumption measurements become. As a rule, the duration of a single measurement is 1 hour, during which the load of the tested engine should be kept constant. In order to estimate the uncertainty of the obtained results, the procedure should be repeated 4–5 times, further increasing its complexity (and costs). Therefore, such tests need to be carefully planned and prepared, properly synchronising the implementation of the energy and emission measurements of the engine with the routine activities of the ship's crew during the voyage.

Simultaneous observations of the engine control parameters during the tests characterise the operation of individual functional sub-systems: fuel feed, lubricating oil, cooling, turbocharging, bearing and auxiliaries. They are monitored using a standard measurement system, along with the visualisation option on the operator panel, see Fig. 8.

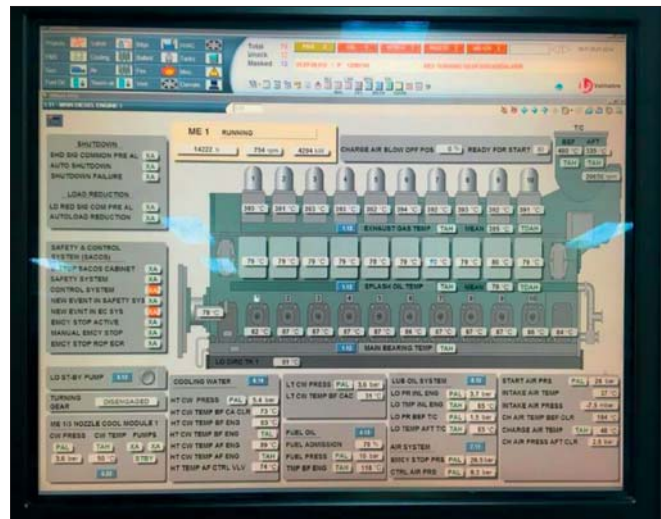

Fig. 8. The operator panel presenting the values of the observed control parameters of the tested engine

Recording the chemical composition of the exhaust components represents the basic metrological activity of the engine emission testing programme in operation. Given that the exhaust gas analysers applied for this purpose are very sensitive to water vapour condensation,⁴ operational measurements should be carried out in the high-temperature part of the exhaust passage, preferably in the control section, directly before or after the turbocharger, where the exhaust temperature is significantly above the acid dew point (approximately 350 – 450 K), see Fig. 9. This temperature depends on the share of sulphuric acid (H_2SO_4), nitric acid (HNO_3) and carbonic acid (H_2CO_3) in the engine exhaust, which in turn depends on the composition of the fuel and air fed into the system.

An additional metrological problem, especially for the measurements calculated at partial engine loads (low exhaust temperature and flow velocity), is the high probability of distorting the results (underestimating the values) by recording

⁴ This leads to the sudden blockage of the measuring cell. In such cases, it should be removed from the measuring device, placed in a very warm place (e.g. on a radiator) and left to dry for several hours.

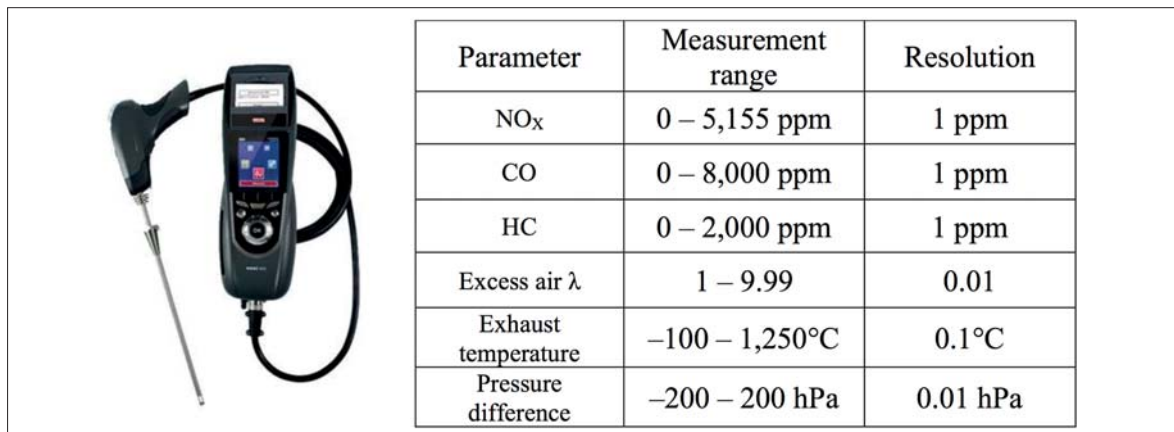

Fig. 9. General view and measurement characteristics of the KIMO Instruments electrochemical exhaust analyser (KIGAZ 300PRO type)

the concentration of toxic and harmful chemical compounds in the engine exhaust as being a consequence of their hydration in flue acid aerosols [13].

The chemical emissivity of the operating marine engine exhaust was tested using a KIGAZ 300PRO analyser, see Fig. 9. The measuring probe was introduced into the gas space behind the turbine of the engine's turbocharger through a branch of the drainage passage, using a properly prepared 'adapter' provided with valves regulating the exhaust flow, see Fig. 10.

As part of verifying the usefulness of the diagnostic equipment used, pilot tests were carried out in real marine engine operating conditions. The concentration of gaseous components in the exhaust was measured at representative engine loads (25%, 50%, 75% and 100%), after reaching the steady thermal state of its construction structure. This means that the cooling system 'kept up' with the reception of heat fluxes from the elements of the piston-cylinder group, which directly absorbed the heat released in the process of fuel combustion in the combustion chamber. For the type of marine engine considered, the duration of the transient process from one steady state to another is approximately 30 minutes. The recording of the emitted exhaust parameters commences in the last three minutes of steady engine running at a given load. The obtained results were approximated with linear functions and then averaged, rejecting the values from the first 30 seconds. The results were affected by gross errors, due to disturbances in the exhaust passage around the analyser measuring probe, inserted into the measuring pipeline through the 'adapter'. Fig. 9. General view and measurement characteristics of the KIMO Instruments electrochemical exhaust analyser (KIGAZ 300PRO type)

RESULTS AND DISCUSSION

In order to verify the proposed method of determining the exhaust emissions of the considered type of marine engine in operating conditions, its energy and emission parameters were measured during steady operations, at a load of $0.77 P_{nom}$, see Table 2. Such a level of engine load resulted from the need to maintain the adjusted speed of a ship during a routine voyage



Fig. 10. Method of introducing the measuring probe of the exhaust analyser into the turbine exhaust duct of the turbocharger in the tested engine (a) and the view of the measurement set during the test realisation (b): 1 - drainage channel [21], 2 - magnification

in pre-determined external conditions (sea state, wind speed and direction). For these working conditions, the values of the specific emissions and the intensity of the emissions of the basic harmful and toxic chemical compounds in the engine exhaust were determined when the engine was fed with RMD 80 type – ISO 8217 marine fuel (Table 2, Fig. 11) according to the developed calculation model and algorithm (Figs. 2 and 3).

During the calculations, it was necessary to assume the value of the engine's mechanical efficiency η_m , in order to determine its effective power P_e from the indicated power P_i obtained from the measurements. However, to determine the actual value of η_m , the Willans characteristic should be developed for the tested engine under RMD 80 fuel feed conditions, according to the method described in the previous section of this article. The problem is that in the voyage conditions of the ship engine tests, this is an organisationally complicated and costly activity, taking into account the fact that hourly fuel consumption may

Tab. 2. Registered (averaged) values of the working parameters of the tested engine fed with RMD 80 marine fuel and the calculated values of the specific emission of toxic and harmful chemical compounds in the exhaust

Recorded energy and emission parameters									
P_i/n_{sc} kW/min ⁻¹	\dot{m}_{fuel} kg/h	λ -	SFOC g/kW·h	P_e kW	r_{O_2} %	r_{CO} ppm	r_{CO_2} %	r_{NO_x} ppm	r_{HC} ppm
4418/750	833	2.8	193	4307	13.47	19.95	5.61	1,093	42
Specific emissions and emission intensity of the basic toxic and harmful chemical compounds in the exhaust									
e_{N_2} g/kW·h	e_{O_2} g/kW·h	e_{H_2O} g/kW·h	e_{CO_2} g/kW·h	e_{NO_x} g/kW·h	e_{HC} g/kW·h	e_{CO} g/kW·h	E_{CO_2} kg/t _{fuel}	E_{NO_2} kg/t _{fuel}	E_{HC} kg/t _{fuel}
5,758.14	1.000662	0.14382	656.1567	11.04068	0.178633	0.148489	3,393.07	57.09277	0.923733
E_{CO} kg/t _{fuel}	\dot{E}_{CO_2} kg/h	\dot{E}_{NO_x} kg/h	\dot{E}_{HC} kg/h	\dot{E}_{CO} kg/h					
0.767853	2826.428	47.55828	0.76947	0.639622					

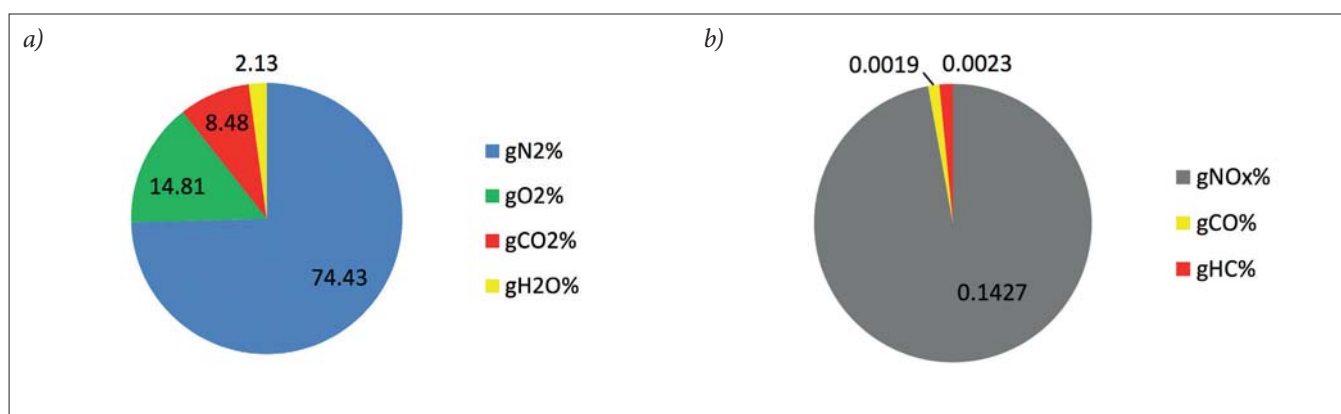

Fig. 11. Gaseous chemical composition of the exhaust of the tested engine powered by RMD 80 marine fuel: a) mass fractions of basic (N_2 , O_2 , H_2O) and harmful (CO_2) chemical compounds; b) mass fractions of toxic compounds (NO_x , CO , HC)

exceed 1,000 kg/h, the time period of a single measurement series should not be shorter than 1 hour and the minimum number of measurement series at the representative (according to the standard) engine loads should be 16–20.

In the next stage of the research, analogous emission calculations for the same engine were computed for the full range of load alterations (0.25, 0.50, 0.75 and 1.00 P_{nom}) using the measurement data from tests carried out in the manufacturer's dynamometer test bed, which are included in the technical documentation. In this way, the full emission load profiles of harmful and toxic gas components in the engine exhaust were developed in accordance with the ISO 8178-4 standard for the E2 cycle (propulsion engines operating at constant rotational speed), using the calculation model elaborated for this purpose (Fig. 2). The representative results of the tests are presented in Fig. 12. It was finally possible to determine the weighted average of the specific emission of NO_x in the exhaust gases of the considered engine fed with MDO/DMC – ISO 8217 distillate fuel, which could be compared with the limit value established by the IMO (Tier emission standard for the marine engine exhaust), see Fig. 12f.

By analysing the chemical emission profiles of the engine exhaust gases in terms of NO_x and hydrocarbons (HC) determined on the basis of the available measurement data, it was possible to observe the full quality compliance of the courses obtained by means of the elaborated calculation

model with the manufacturer's courses, see Figs. 12c and 12d. The particular quantitative discrepancy was systematic and most likely resulted from the simplifying assumptions made in the computational models used by the author and the manufacturer as well as from various techniques and measuring instruments applied during the research tests. It is easy to compensate for these alterations by introducing an appropriate (constant) calculation correction, shifting the obtained courses by a determined vector $\vec{V} = [v_x, v_y]$, where v_x and v_y represent the adequate coordinates of the vector.

In assessing the nature of the impact of the engine load on the specific emissions of harmful and toxic gaseous components in the exhaust, it can be generally stated that it is consistent with the results published in specialist literature [10, 19]. The exhaust temperature is of particular importance here,⁵ because it determines the course of the chemical reactions stimulating the formation of NO_x (with a specific proportion of nitrogen oxide NO and nitrogen dioxide NO_2 in the exhaust) and carbon monoxide (CO) in the combustion process. The numerical data in the load profile (Fig. 12c) show that the lowest emission of NO_x occurred at 50% engine load and increased with increasing load, accompanied by a corresponding increase in exhaust temperature. An interesting phenomenon occurred

⁵ With negligible significance of possible alterations in the percentage contribution of nitrogen to the feed air.

in the range of lower engine loads, where despite significantly lower exhaust temperatures, the emission of NO_x increased in value. The main reason for this phenomenon was the increased exposure time of NO within the engine gas (working) space, accompanied by its intensive oxidation to NO_2 , with a higher molecular mass. This is a well-known emission feature of diesel engines, in which the highest value of the NO_2/NO ratio occurs at the lowest ranges of the engine load and crankshaft rotational speed [10]. In addition to the assumption of the molecular mass of unburnt HC), this is one of the main reasons behind the possible discrepancies in the results of the stoichiometric (theoretical) calculations of the exhaust, e.g. when determining the substitutive molecular mass of a stoichiometric mixture.

The profiles presented also confirm that the partial load was definitely unfavourable, not only for the course of the energy and thermal-flow processes carried out in the marine engine, but also for the chemical emissions in the engine exhaust. In the case of CO_2 , as a non-toxic gas responsible for the greenhouse effect, alterations within exhaust-specific emissions are closely correlated with changes in specific fuel consumption and the gas is known to be the reciprocal of the total engine efficiency. Therefore, the higher the efficiency of the energy transformation processes in the engine, the lower the specific quantity of fuel necessary to generate net power from 1 dm³ of its cylinder capacity and the lower the specific CO_2 emissions e_{CO_2} , see Figs. 12a and 12b.

A lower engine load implies a lower dose of fuel being injected into the combustion chamber, where the pressure and the temperature of the feed-compressed air are relatively low, resulting in deteriorating conditions for the formation of a fuel droplet cloud. This is reflected in the reduced quality of the atomisation process (accuracy and uniformity), evaporation and mixing the fuel vapours with air and self-ignition of the fuel-air mixture. This results in the excessive, local or general enrichment of the combustible mixture in the combustion chamber, leading to incomplete and imperfect combustion. An observable symptom of this situation was the increased emissions of CO and unburnt HC in the engine exhaust gas, see Figs. 12d and 12e.⁶

A slight increase in the specific emission of CO at the nominal load is most likely related to the phenomenon of CO_2 dissociation at high temperatures [10]. Increasing the amount of unburnt HC in the exhaust at low engine loads and especially at idling speed is also exacerbated by the extinction of the flame near the much cooler surfaces of the combustion chamber, or by retaining HC in the so-called dead spaces in the combustion chamber, e.g. in the vicinity of the starting valve. Traces of the unburnt HC can be easily located through endoscopic examinations of the engine's working spaces [3, 5, 6].

Based on the emission load profile of NO_x in the engine exhaust determined for the E2 cycle, its weighted average was calculated and compared with the limit value established by the IMO in the Tier I emission standard (Fig. 12f). The limit

value of the weighted average specific emission of NO_x for medium-speed engines ($130 < n_{\text{CS}} < 2,000 \text{ min}^{-1}$) installed on board ships constructed on or after 1 January 2000 but before 1 January 2011 was determined using the following empirical formula: $\bar{e}_{\text{NOx}} = 45 \cdot n^{-0.2} \text{ g/kW}\cdot\text{h}$. The numerical data on the profile indicated that the values of the weighted average specific emission of NO_x specified by the manufacturer (11.30 g/kW·h) and the one obtained as a result of the application of the calculation model proposed in this article (9.29 g/kW·h) did not exceed the limit value of 11.97 g/kW·h.

Appropriate numerical values, obtained during the engine tests under RMD 80 fuel feed conditions and using the developed calculation model, were applied to all emission load profiles of harmful and toxic gases in the exhaust of the considered engine. They revealed that, in relation to the representative engine load of $0.77 P_{\text{nom}}$, the exhaust chemical emissivity changed slightly, while the direction of the observed changes was different. On the one hand, the specific emission of NO_x increased (11.0407 g/kW·h), certainly influenced by a significant growth in the average exhaust temperature (by about 25 K). The content of NO_x in the exhaust of the considered engine type can be minimised by the electronic control of the fuel injection advance angle α_{ia} (5–13° CSR before TDC) in the common rail system. The lower the value of α_{ia} , the lower the maximum combustion pressure, temperature and NO_x emission, but this situation occurs at the cost of a corresponding increase in specific fuel consumption.

On the other hand, it can be concluded that the application of RMD 80 fuel had a positive impact on the energy efficiency of the engine, the measurable effect of which was a significant reduction in the specific emission of CO (0.14849 g/kW·h) and unburnt HC (0.17863 g/kW·h) in the engine exhaust, with a slight increase in specific fuel consumption (193.4 g/kW·h) and specific CO_2 emission (656 g/kW·h). Such a trend of changes means a significant departure from the conditions of incomplete and imperfect fuel combustion.

Fig. 12. Load profile for the specific emissions of harmful and toxic gaseous components in the exhaust of MAN Diesel 10L32/44CR type fed with MDO/DMC– ISO 8217 distillate fuel with plotted numerical values corresponding to the engine feed conditions with RMD 80 – ISO 8217 marine fuel, at a load of $0.77 P_{\text{nom}}$

FINAL REMARKS AND CONCLUSIONS

On the basis of the experimental research programme conducted, an innovative methodology for testing newly produced marine fuels was developed in the real operating conditions of a high-power diesel engine. This article represents a kind of methodological guide for producers of marine fuels, to which it is mainly addressed, who will be able to comprehensively assess the suitability of their products for feeding marine engines. Shipowners of sea-going vessels will also be able to take advantage of this possibility before deciding whether to widely implement into operation a new type of marine fuel.

⁶ According to the results of research published at the end of the last century by Lloyd's Register of Shipping, the average values of the specific emissions of CO and unburnt HC in the exhausts of medium-speed marine engines are 1.8 and 0.6 g/kW·h, respectively.

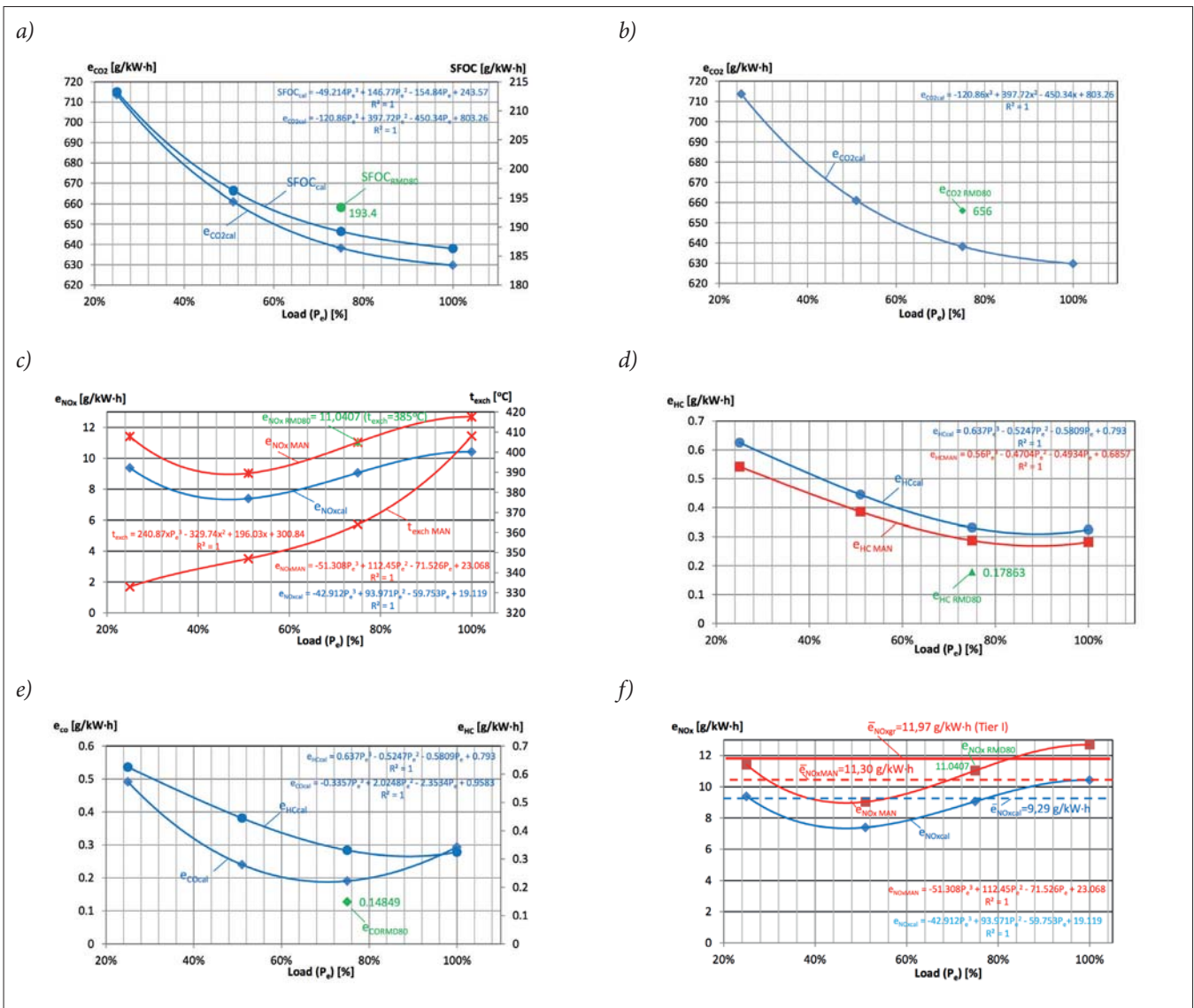

Fig. 12. Load profile for the specific emissions of harmful and toxic gaseous components in the exhaust of MAN Diesel 10L32/44CR type fed with MDO/DMC- ISO 8217 distillate fuel with plotted numerical values corresponding to the engine feed conditions with RMD 80 - ISO 8217 marine fuel, at a load of 0.77 P_{nom}

The results of operational tests, conducted on the chemical exhaust emissions from the MAN Diesel engine 10L32/44CR type of a ship's main propulsion system, positively verified its control compliance in this respect (standard measurement system) and the usefulness of the implemented diagnostic system as well as the developed calculation model. It is also possible to elaborate a full load profile of the specific emission of toxic gases within the engine exhaust and to calculate their weighted averages under the conditions of feeding with newly implemented marine fuels. This would additionally enable a comparative analysis of the obtained emission courses in terms of the quality of the energy transformation processes worked out in the engine as well as an assessment of compliance with the IMO's emission requirements. The synthesis of these considerations provides the basis for rational decision making regarding the further application of the tested fuel in the engine operation process.

The proposed methodology for experimental testing may also be implemented for the operation of other types of marine

engines, provided that the basic chemical composition of the fuel feed and the engine load profiles to the hourly fuel consumption are known. Moreover, there is the possibility of indicating the cylinders and measuring the chemical composition of the engine exhaust in the high-temperature part of the exhaust passage.

REFERENCES

1. M. Janić, Advanced transport systems: Analysis, modelling, and evaluation of performances. 2014.
2. J. Janota, 'Przepływomierze masowe Coriolisa', Konferencja „Smary i Oleje”, 2020. ['Coriolis mass flow meters'].
3. Z. Korczewski, Endoskopia silników okrętowych. 2008. [Endoscopy of marine engines].

4. Z. Korczewski, 'Contemporary diagnostic methods for ship engines: A report on scientific research activity of the Polish Naval Academy in this field', Polish Maritime Research. 2008.
5. Z. Korczewski, 'Analysing the potential for application of the phase shift method in endoscopic examination of marine engines', Polish Maritime Research. 2013.
6. Z. Korczewski, 'Diagnostyka eksploatacyjna okrętowych silników spalinowych – tłokowych i turbinowych'. Wybrane zagadnienia. 2017. ['Operational diagnostics of marine internal combustion engines – piston and turbine'].
7. Z. Korczewski, 'The method of energy-efficiency investigations of the newly produced marine fuels through an application of the laboratory diesel engine', New Trends in Production Engineering. Proceedings of the International Conference. 2018.
8. Z. Korczewski, 'Thermal efficiency investigations on the self-ignition test engine fed with marine low sulphur diesel fuels', Combustion Engines. 2019.
9. J. Kowalski, 'An experimental study of emission and combustion characteristics of marine diesel engine with fuel injector malfunctions', Polish Maritime Research. 2016.
10. J. Merkiś, L. Piaseczny and T. Kniaziewicz, 'Zagadnienia emisji spalin silników okrętowych'. 2016. [Marine engine exhaust emissions].
11. S. Neumann, R. Varbanets, O. Kyrylash, V. Maulevych, and O. Yeryganov, 'Marine diesels working cycle monitoring on the base of IMES GmbH pressure sensors data', *Diagnostyka*. 2019.
12. F. Pearce, 'Confessions of an eco sinner'. 2008.
13. T. Reiner and F. Arnold, 'Laboratory flow reactor measurements of the reaction $\text{SO}_3 + \text{H}_2\text{O} + \text{M} \rightarrow \text{H}_2\text{SO}_4 + \text{M}$: Implications for gaseous H_2SO_4 and aerosol formation', *Geophysical Research Letters*. 1993.
14. T. A. Tran, 'A research on the energy efficiency operational indicator EEOI calculation tool on M/V NSU JUSTICE of VINIC transportation company, Vietnam', *Journal of Ocean Engineering and Science*. 2017.
15. R. Varbanets, V. Zalozh, A. Shakhov, I. Savelieva, and V. Piterska, 'Determination of top dead centre location based on the marine diesel engine indicator diagram analysis', *Diagnostyka*. 2020.
16. R. Varbanets et al., 'Acoustic method for estimation of marine low-speed engine turbocharger parameters', *Journal of Marine Science and Engineering*. 2021.
17. J. Wysocki, 'Analysis of the energy efficiency operational indicator in economic and ecological aspect', *Scientific Journal of Gdynia Maritime University*. 2017.
18. K. Witkowski, 'Problematyka zanieczyszczenia atmosfery przez statki wykorzystywane w transporcie morskim', *Autobusy*. 2016. [Atmospheric pollution by ships used in maritime transport'].
19. Z. Yang, Q. Tan and O. Geng, 'Combustion and emissions investigation on low-speed two-stroke marine diesel engine with low sulphur diesel fuel', *Polish Maritime Research*. 2019.
20. Germanischer Lloyd SE, *Rules for classification and construction: Additional rules and guidelines*. 2013.
21. MAN Diesel Shop Test Protocol, *Measurement recordings and performance data of the MAN 10L32/44CR type engines*. 2009.
22. MARPOL 73/78 Convention, annex VI: *Regulations for the prevention of air pollution from ships (entered into force on 19 May 2005)*.
23. Resolution MEPC. 231(65) adopted on 17 May 2013, *Guidelines for calculation of reference lines for use with the Energy Efficiency Design Index (EEDI)*.

NOMENCLATURE OF MAJOR NOTATIONS

Parameters

D	– cylinder bore
e, E	– specific emission of the gas component in the exhaust, in g/kW·h and kg/tonne, respectively
\bar{e}	– weighted average specific emission of the gas component in the exhaust
\dot{E}	– emission flow of the gas component in the exhaust
g	– mass contribution
i	– number of cylinders
L_{CR}	– connecting rod length
L_i, O_i	– theoretical air and oxygen requirement for complete combustion of 1 kg of fuel
M	– substitutive molecular mass
m	– mass
\dot{m}	– mass flow
n_{CS}	– rotational speed of the engine crankshaft
P_i, P_e	– engine power, indicated and output (net, effective), respectively
R	– substitutive gas constant
r	– volume contribution
S	– piston stroke
T, t	– temperature: in K and °C, respectively
η_m	– mechanical efficiency
λ	– excess air ratio

Abbreviations, symbols and subscripts

CS	– crankshaft
CSR	– crankshaft revolution
FO	– firing order
SFOC	– specific fuel consumption
SN	– the number of strokes per single engine cycle
TC	– turbocompressor
TDC	– top dead center
<i>e</i>	– effective, net
C, H, S, N, O	– mass distribution in fuel: carbon, hydrogen, sulphur, nitrogen and oxygen, respectively
<i>exch</i>	– exhaust
<i>fuel</i>	– concerns the fuel
<i>i</i>	– indicated
<i>lt</i>	– boundary, limit
<i>m</i>	– mechanical
<i>t</i>	– theoretical

CONTACT WITH THE AUTHORS

Zbigniew Korczewski

e-mail: z.korczewski@gmail.com

Gdańsk University of Technology
Gabriela Narutowicza 11/12, 80-233 Gdańsk
POLAND