



ASME Accepted Manuscript Repository

Institutional Repository Cover Sheet

First

Last

ASME Paper Title: Development of Technical Creativity Featuring Modified TRIZ-AM Inventive Principle to Support De
for Additive Manufacturing

Authors: Siti Nur Humaira Mazlan, Aini Zuhra Abdul Kadir, Mariusz Deja, Dawid Zielinski, Mohd Rizal Alkahari

ASME Journal Title: JOURNAL OF MECHANICAL DESIGN

Volume/Issue _____ Date of Publication (VOR* Online)
_____ 18.10.2021 _____

ASME Digital Collection URL: https://asmedigitalcollection.asme.org/mechanicaldesign/article/doi/10.1115/1.4052758
elopment-of-Technical-Creativity-Featuring?searchresult=1

DOI: <https://doi.org/10.1115/1.4052758>

*VOR (version of record)

Development of Technical Creativity Featuring Modified TRIZ-AM Inventive Principle to Support Additive Manufacturing

Siti Nur Humaira Mazlan¹

School of Mechanical Engineering,
Universiti Teknologi Malaysia, Skudai,
81310, Johor Bahru, MALAYSIA,
myrah92@yahoo.com

Aini Zuhra Abdul Kadir¹

School of Mechanical Engineering,
Universiti Teknologi Malaysia, Skudai,
81310, Johor Bahru, MALAYSIA
ainizuhra@utm.my

Mariusz Deja²

Gdańsk University of Technology,
Faculty of Mechanical Engineering and Ship Technology,
Department of Manufacturing and Production Engineering,
Gabriela Narutowicza 11/12, Gdańsk, 80-233, POLAND
mariusz.deja@pg.edu.pl

Dawid Zieliński²

Gdańsk University of Technology,
Faculty of Mechanical Engineering and Ship Technology,
Department of Manufacturing and Production Engineering,
Gabriela Narutowicza 11/12, Gdańsk, 80-233, POLAND
dawid.zielinski@pg.edu.pl

Mohd Rizal Alkahari³

Faculty of Mechanical Engineering,
Universiti Teknikal Malaysia Melaka,
Hang Tuah Jaya, 76100, Durian Tunggal, Melaka, MALAYSIA
rizalalkahari@utem.edu.my

¹ Email corresponding author: ainizuhra@utm.my

ABSTRACT

The design for additive manufacturing (DFAM) processing was introduced to fully utilise the design freedom provided by additive manufacturing (AM). Consequently, appropriate design methodologies have become essential for this technology. Recently, many studies have identified the importance of DFAM method utilisation to produce AM parts, and TRIZ is a strategy used to formalise design methodologies. TRIZ is a problem-solving tool developed to assist designers to find innovative and creative solutions. However, the pathway for synergising TRIZ and DFAM is not clearly explained with respect to AM capabilities and complexities. This is mainly because most methods continue to involve use of the classical TRIZ principle, which was developed early in 1946, 40 years before AM technologies were introduced in the mid-1980s. Therefore, to tackle this issue, this study aims to enhance the 40 principles of classical TRIZ to accommodate AM design principles. A modified TRIZ-AM principle has been developed to define the pathway to AM solutions. TRIZ-AM cards are tools that assist designers to select inventive principles (IPs) in the early phases of product design and development. The case study illustrates that even inexperienced AM users can creatively design innovative AM parts.

1. INTRODUCTION

Additive manufacturing (AM) expands the scope of conventional manufacturing methods because parts are created by extruding and adding the material in layers as opposed to the subtracting method. AM has opens many doors for creative design improvement and efficiency, which supports product customisation. Today, selection of appropriate manufacturing methods and machine tools is one of the main critical decisions in the product development process [1]. AM technology can be categorised as a new generation of flexible manufacturing systems (FMS) in which a variety of products made of different materials can be produced at low cost using the same machine [2]. For conventional design methods, such as designs for manufacture and assembly (DFMA), the concept is widely available in the design practice to simplify and modify the design for conventional manufacturing parts [3]. However, when AM was introduced, the technology provided an opportunity to re-think design for manufacture and assembly (DFMA) in order to benefit from AM capabilities. Therefore, the terms introduced to describe design for additive manufacturing (DFAM) specifically identified AM's potential, such as design freedom. DFAM is defined as a set of rules, guidelines, tools and knowledge [4,5] that assist designers to consider AM during product design and development (PDD). However, existing DFAM approaches often apply subtractive manufacturing methods adapted for AM. This is impractical because the inherent process of each method is fundamentally different [6].

The definition of appropriate process-specific design rules [7] and tools is still a key factor for achieving the full potential of AM. The relevant procedures and macros based on developed empirical models and design practice can be embedded in improved CAD systems to support DFAM. This enables corrective action to be taken at the design stage to fabricate required

functional features, as shown in the example of small diameter holes produced by direct metal laser sintering [8]. The part design for AM must involve consideration of desired geometry, product attributes and manufacturability aspects, such as processing time, manufacturing cost, surface finish and achievable dimensions [9]. The decision support methods can be used to compare different additive manufacturing approaches or a standard subtractive method with an additive manufacturing approach. A multi-criteria decision-making method (MCDM), called an analytic hierarchy process (AHP), was used by Deja et al. [10] for selection of the most suitable technology for manufacturing components for offshore machinery.

The objective of DFAM is similar to the goals of TRIZ (Theory of inventive problem solving) in that it provides tools for innovative and creative solutions to design problems arising during PDD. TRIZ was invented to help engineers and scientists to solve problems using the knowledge of former inventors. The essence for supporting these solutions was consolidated into 40 Inventive Principles (IPs), and a contradiction matrix was introduced to identify the best and worst parameters for solving the problems [11]. TRIZ used the concept of world knowledge, based on proven successful patents investigated by the founder, G. Altshuller. TRIZ is designed not only for engineers but also for universal applications; therefore, integration of TRIZ with DFAM simplifies the design process and can lead to faster ideation and innovation. TRIZ was also recognised for its efficiency and systematic product ideation [12] and is used in many fields of expertise, such as automation, product and technology innovation and business management. Statistics show that 61% of respondents applied TRIZ for product and technology innovation [12]. Recent findings show that implementation of TRIZ strengthened the innovation

and productivity of new product targeting for small and medium enterprises (SMEs), contributing to sustainable business operations [13].

TRIZ is accepted in most industrial companies because it promotes rapid product innovation and, at the same time, increases competitiveness. In order to validate the applicability of TRIZ in the industry, a survey was conducted by Spreafico and Russo [14] to demonstrate the main contributions of TRIZ. This showed that TRIZ contributed 51% for quality improvement, 25% for reduction of product pollution, 23% to new product introduction (NPI), 21% of productivity improvement, 18% of the product and process innovations, 6% in energy reduction, 6% of safety improvement and 2% of cost reduction. Evidence of successful implementation of TRIZ in many industries indicates that applicability of TRIZ under AM design practice may benefit a wider range of users. In particular, integration of TRIZ-DFAM will promote use of DFAM among TRIZ users.

Synergising DFAM and TRIZ appears to be easy; however, it can be complex without effective implementation. This is because the classical TRIZ solution cannot directly be used to provide a solution for AM unique capability. This statement has been supported by several TRIZ-related studies [15] [10, 15-17]. Consequently, the inventive principles provided by TRIZ are incapable of supporting the overall concept of AM unique capabilities involving DFAM because direction to the solution is not specifically described as unique to AM. It is worth noting that the IPs are initially meant for the classical TRIZ where the solution focuses only on the conventional manufacturing method; thus, the contradiction matrix is necessary to eliminate the manufacturing difficulties in that particular manufacturing method. When AM was introduced, use of the contradiction matrix to problem solve became impenetrable, tricky

and complex because AM technology already eliminates the manufacturing difficulties imposed by conventional manufacturing.

Therefore, to overcome these limitations, this study presents modified TRIZ-AM inventive principles to assist product design and development for AM. TRIZ-AM cards are used as the design tools for IPs selection. The modified TRIZ-AM presents enhancement of the definition from the context of classical TRIZ to TRIZ-AM. This involves AM complexities such as shape, function, hierarchy and material.

At the end of the development, an illustrative case study was conducted to validate the efficiency of the newly-developed method in showcasing the design improvement by comparing the design before and after implementation of the proposed method. For this purpose, a group of designers was chosen to conduct the case study.

The outline of this paper is shown below:

Section 1 introduces the study; section 2 describes the overview of DFAM-related studies, such as the DFAM method and TRIZ; section 3 presents the methodology; section 4 provides the case study demonstrating usage of TRIZ-AM cards; and finally, section 5 presents the conclusion and future work.

2. Design for Additive Manufacturing – State of the Art

DFAM is defined as the methodology and tools that assist designers to take into account the specifics of additive manufacturing, whether in a technological or geometrical context or as a post-processing technique during the product design stages [19]. In addition to the perspective of DFAM described in the design phases, this design theory is also used for product

modification or re-design of a product that has usually been built using traditional manufacturing. AM is revolutionising and growing; thus, it is not only the proposed tool for analysing design problems but is also used as the proposed tool for generating ideas [10]. The AM process differs from the traditional process in terms of batch size, production time and manufacturing cost; thus, AM requires a different approach and methodology to control and predict the quality of parts [20]. This includes a new approach to explore large and complex design spaces, new materials, multi-scale structures and the cognitive barrier that was imposed by past experience using the conventional process.

DFAM provides numerous advantages and benefits, especially for design freedom, material choice, freeform geometry [21] and cost-effective production of part customisation, mass-customised products [22] and generative design [23]. In order to support the manufacturing capabilities, several methods were introduced, based on parametric optimisation [24] or axiomatic design [25]. Studies have considered whether the tool for generating ideas in AM should be based on the database of AM functionalities [26] or intermediate representation (IR), which involves a creative approach [27], topology optimisation [28] and part consolidation [29]. However, the approach of existing DFAM methods has certain limitations, focusing on creativity and innovation early in the design innovation process. Thus, in order to overcome this cognitive barrier, it is essential to introduce a methodology at the earliest stage of the design phase because, during this phase, creativity is unlocked [27]. Therefore, to implement the DFAM in design and manufacturing processes, several methods have been introduced to assist designers in the selection of appropriate ways to produce AM parts. There are four guides to assist designers in selection of suitable DFAM methods [30]:

- i. Components where AM can be beneficial
- ii. Components where AM can be beneficial but where risks and expectations must be considered and inspected
- iii. Components that do not need to use AM because no benefits are expected
- iv. Components where AM has no benefits at all in terms of manufacturing methods

The above-mentioned elements or criteria help in decision making when choosing the most suitable design method for DFAM, creating an opportunity to add value to the product development and thus having an advantage over conventional manufacturing methods.

2.1 DFAM – A Creative Approach

In the past few years, it can be observed significant progress of DFAM approaches including creativity enhancement methods used in DFAM. Depending on the main purpose of the applied DFAM methods, they can partially allow creative ideas and concepts to be generated for designers. For this reason, to enhance design creativity in AM, several approaches have been developed, which can be used in the early stages of the design process. For example, Rias et al. [31] proposed a creative approach of DFAM called Creative-DFAM, which framework included 5 stages; features discovery, exploration, ideas evaluation, concept generation, and concept evaluation. The illustrated creative concept was based on a turbine blade design that considered new functions and forms of the part.

Briard et al. [23] proposed a methodology in combining DFAM and generative design (G-DFAM) to tackle the complex optimized part for metal 3D printing. Four steps consists of translation, initialization, AM guidelines, and refinement were presented. Besides that, additive

manufacturing knowledge (AMK) was introduced to produce higher quantity of solutions dedicated to DFAM. In the study, AMK-specific cards were produced based on the objective-oriented of AMK specifics such as lightweight, performance improvement, customization, value-added, the complexity of free, compactness, and also cost reduction. Results showed that 41% of the participant agreed that AMK is helpful to assist DFAM [32]. Chekurov et al. [33] conducted an assignment that involved the participants from fourth year and Master's students with a Mechanical Engineering background. The aims are to validate the efficacy and quality of the student performances after conducting the AM course for over five years. The findings reported that the DFAM course assignment has been useful to assist the communication skills and ideas in their work careers.

Other similar work by Prabhu et al. [34] where design tools and educational interventions to integrate DFAM in Engineering Design was proposed. During the workshop, participants were given an opportunity to generate ideas based on the given case studies. Overview of how the Laser Powder Bed Fusion (LPBF) works to accommodate the opportunistic aspects of DFAM such as part consolidations, creating complex geometries, and reducing printing time was presented. Opportunistic DFAM (O-DFAM) and restrictive DFAM (R-DFAM) were then discussed further to compare different variations in DFAM education [35]. The tasks were carried out by the students with DFAM self-efficacy, self-reported DFAM use, and also design creativity. Results showed that the students that were trained using R-DFAM generated advanced creative ideas followed by O-DFAM.

2.2 Other Development of DFAM Methods

Other DFAM method such as part consolidation (PC) has also been reported. It is one of the favorable DFAM methods because it is economical and easy to be adopted in the industry. It is defined as a process in which multiple parts are merged, enabling design changes without compromising and disrupting the functionality of the components [36]. Newest findings on PC articles had presented a novel integration between PC and topology optimization (TO) to determine the ideal number of parts, geometry, optimal joining pattern for an assembly-level design. Studies created multiple layered design domains that can optimize the complex structure, support structure volume, surface area, and also the number of joints to minimize the total cost for final assembly [37]. TO is a computational approach for optimizing the distribution of material to minimize design constraints. The customization of automotive components involves an overhang and build time case study were among the recently reported work of TO in AM. The study concludes that by implementing the TO in automotive customization, superior part functionality with cost and material can effectively be obtained [38].

In addition, agile development methods were introduced as one of the approach to develop components for DFAM. Reichwein et al. [39] adapted the agile framework scrum to design for AM. In the proposed framework, the product development is divided into small tasks involving sprint planning, sprint, sprint review, and minimum viable product (MVP). The scrum team at the sprint phases came from various backgrounds such as opportunistic DFAM, restrictive DFAM, printing, and testing. The study came out with the fresh idea to apply DFAM based on software development methodologies. A new DFAM methodology was presented

which covered the ideas from AM process selections, product redesign for functionality enhancement, and also product optimization based on the AM process that was selected [40]. Following that, another DFAM methodology was developed to integrate the product function integration and structure simplifications [41]. In the design process activities, six steps were proposed which include the functional analysis, design synthesis, 3D CAD modelling, TO, process planning and fabrication/ printing.

Integration of DFAM and Axiomatic Design (AD) theory was presented by Renjith et al. [42], in which AD and TRIZ were integrated with consideration of the AM environment. AD was used to systematically define and analyze a design problem, while TRIZ can be used to generate the innovative solution for a design problem. A case study was presented to validate the efficiency of the developed framework. This study uses the system to link with identified design parameters and, collectively, AM capabilities in a database. Later, Renjith et al. [15] upgraded the system database synergizing between AD and TRIZ by adding the design parameters related to AM capabilities, such as internal channels, lattice structure, freeform shape and others.

2.3 Utilisation of the TRIZ Method with DFAM

TRIZ is a theory of problem solving based, initially, on over 200,000 patents, then narrowed down to 40,000 patents. The essence to support these solutions was consolidated into 40 inventive principles (IPs). These inventive principles, also known as innovation principles, guide designers towards the transformation axis based on their design problems. In AM, there have been successful attempts to apply TRIZ methodology, especially in a context of DFAM. For example, AM applications were successfully integrated within the TRIZ inventive

principle and have been classified into DFAM, laser-beam based AM (LAM) and additive manufacturing process characteristics (AMPC). A total of 40 AM examples were classified according to the 40 TRIZ inventive principles. Two examples of DFAM applied to TRIZ were also presented, which involves the design of a high pressure hydraulic valve and design of a counter-flow heat exchanger profiting [16].

Several studies have proposed the linkage mixing TRIZ-DFAM, such as a new TRIZ matrix specific to AM, by defining the characteristics of AM as the criteria for innovation [43]. According to this study, even though the creation of a specific TRIZ matrix to AM was successful to improve on the re-design process, using TRIZ alone did not simplify the design because the roadmap to the specific solution is not always clear. From this perspective, it is interesting to identify the actual problems when the classical TRIZ inventive principle is directly adapted to the AM roadmap. The study by Kamps et al. [17] focuses on the integration of TRIZ, biomimicry and DFAM. They argue that the first step should be to allow designers to develop the basic design, and then improve the part design using the biomimicry database. The intersection between the biomimetic designs was conducted using a TRIZ inventive process. Latterly, TRIZ is mainly employed to solve technical problems and the contradiction matrix is used systematically to re-design AM parts.

There are many successful case studies using the integration of TRIZ and DFAM, such as the development of a new concept of the 3D printed vibratory scaffold for cell structures [44], a customised ear cap for medical treatments [45], and development of a pen capable of drawing neat, straight and accurate dotted lines by adapting TRIZ to produce aesthetically appealing and easy-to-operate products [46]. Previously, Bariani et al. [47] used TRIZ having discovered that

this method is more effective for solving the part count reduction problem. They devised a new approach by merging all the common characteristics and connecting the components of one or two methods to redesign the satellite antenna. Bariani et al. [47] identified two common characteristics of DFMA and TRIZ which are:

- (1) Each design approach uses the 'psychological tool' to inspire the user by providing the existing solution. The most common is minimum part criteria input and the final output;
- (2) Use of the 'product simplification' method in the design process to reduce the number of components or assemblies

These two criteria were also applied to the DFAM approach. DFAM principles, however, are superior, having the capability of enhancing ideation to create an innovative, aesthetically appealing [48], complex and organic-looking product. Therefore, the idea of combining TRIZ and DFAM serves to inspire and encourage designers to think additively. Thinking additively in the context of designers can facilitate creative thinking because fostering inventiveness is more probable when they have space in which to trigger new ideas, which is the concept and principle applied in DFAM.

However, as highlighted previously, the common case studies conducted by previous researchers in AM still utilise the TRIZ method with contradiction matrix, which has been referred to as 'classical TRIZ'. Consequently, it provides only a general solution to a specific problem, but the specific solution is not clearly described [43]. It was also observed that TRIZ inventive principles (IPs) with 40 IP instructions (or definitions) form one of the biggest challenges to enhancement of the use of TRIZ with DFAM. The challenge includes resolving

issues related to full utilisation of AM capability in each IP instruction, which limits the usage of AM complexity in terms of shape, functionality, hierarchy and materials.

Therefore, this study aims to enhance the 40 IP instructions by modifying their definitions to accommodate TRIZ with AM design principles. A modified TRIZ-AM IPs was developed to ensure the pathway to the AM re-design solution is clearly described with suitable specific design solution for AM.

3. Methodology

In this section, the methodology to enhance and develop the modified TRIZ-AM IPs definition is described. The overall methodology for integrating modified TRIZ-AM IPs consisting of six steps is presented in Figure 1.

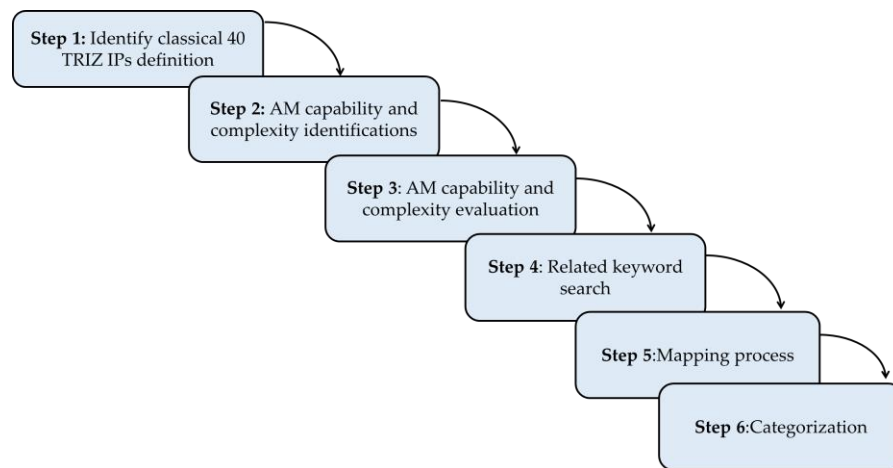

Fig. 1 Six steps to integrate the classical TRIZ definition into a modified TRIZ-AM IPs definition

The six steps are as follows:

- i. Step 1: Identifying a classical 40 TRIZ IPs definition that is compatible with engineering-related descriptions as TRIZ is also used in different fields, such as business and services.
- ii. Step 2: Identifying AM complexity and capability, extracted and labelled.
- iii. Step 3: Evaluating AM complexity and capability for consistency of terminology.
- iv. Step 4: Identifying appropriate keywords and synonyms used in the classical TRIZ 40 IPs in association with AM capability, complexity and AM-related examples.
- v. Step 5: Mapping the process involving classical TRIZ definition into the modified TRIZ-AM definition.
- vi. Step 6: Categorisation of the modified TRIZ-AM definition into several independent sections of study.

Aiming to encourage and support users of TRIZ inventive principles in AM, the study begins by collecting and extracting classical TRIZ definitions that are compatible with the current related topics. This is because TRIZ has been used not only for engineering studies, but also for non-engineering-related areas, such as business and managements [49]. Therefore, the classical TRIZ definition was based on the respective field using these definitions. Thus, it is necessary to extract a definition that is suitable for the aims of this study, in which only the product design and developments employed within the scope of the definition are selected. Next, steps are taken to identify AM complexity and capability, which are clarified, labelled and mapped with the respective classical 40 TRIZ IPs. Relevant search engines and keywords are studied, based on suggested text similarity as well as related AM examples, as shown in Table 1. The mapping

process is then conducted and suitable definitions are planned and executed. Following the successful mapping process, the modified TRIZ-AM IPs are categorised, based on three independent categories, such as design, process, etc.

Table 1 Example of variation keywords and synonyms used for AM complexity and capability searching

| # | Principle | Related keywords and synonyms* |
|----|--------------------|--|
| 1 | Segmentation | Segment, division, separate, breakdown, multiple, section |
| 5 | Merging | Merge, assemble, part consolidation, combine, unite |
| 8 | Anti-weight | Weight reduction, reduced weight, decrease weight, reduce dimensions, lighten, lightweight |
| 40 | Composite material | Reinforced plastic, multi-materials |

*The listed keywords and synonyms represent only the examples based on selected principles.

Figure 2 describes the overall concept of the mapping process of the classical TRIZ definition to the modified TRIZ-AM definition. Descriptions of the mapping ideas are as follows: The first group is coloured green to present the classical definition and marked with index #C-TRIZ P1...#C-TRIZ P40, representing TRIZ original 40 inventive principles from Principle #1 to Principle #40. The second group, coloured orange, presents the modified TRIZ-AM definitions and has indexes showing #TRIZ-AM P1, with sub-indexes of #TRIZ-AM P1.1, #TRIZ-AM P.1.2 representing the sub-principles of #TRIZ-AMP1 to #TRIZ-AM P40, respectively. The red dotted arrow shows the transition from the classical principle to the TRIZ-AM principle. The group was then categorised based on three independent groups of design for additive manufacturing

(DFAM), processes (P), and generic design (G), which is non-AM process related. Following some consideration, the TRIZ-AM principles were categorised into respective groups.

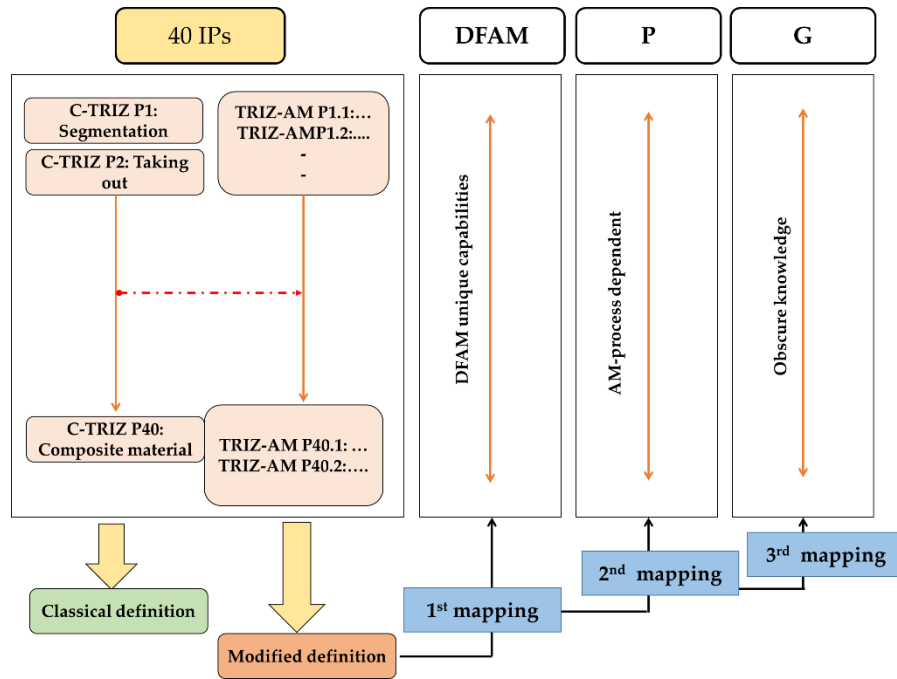

Fig. 2 The classification of modified TRIZ-AM into independent groups

First mapping to identify whether the TRIZ-AM principle has a connection with DFAM unique capabilities and complexities, which are (i) shape complexity, (ii) hierarchical complexity, (iii) material complexity and (iv) functional complexity. Meanwhile, for the second category, which is process (P), if the definition of principle is very-related or near-related to AM DFAM, unique capabilities can also be applied to this group, depending on the definitions of the principles. Lastly, the 40 IPs that were not re-defined or modified to TRIZ-AM definition, having vague principles or principles inapplicable to AM, were grouped under the category of ‘generic design’ (G), which falls under the category of obscure knowledge.

4. Results

This section comprises two sections. Section 4.1 describes the table of modification of classical TRIZ definition and modified TRIZ-AM definition. In addition, TRIZ-AM cards with their respective principles and descriptions are introduced. Section 4.2 presents an illustrative case study conducted with a group of designers to verify the feasibility of these design approaches.

4.1 Modified TRIZ-AM Definition Development

Table 2 presents the development of the modified definition for the TRIZ-AM principle. Out of 40 principles, only 26 principles are successfully enhanced to accommodate the AM capability and complexity; meanwhile, the other 14 principles are not successfully integrated to the AM process and are classified as of generic design because they can be applied to other manufacturing processes. In this modification, the modified TRIZ-AM principle is classified into three respective groups, which are DFAM, AM process dependent (AMPD) characteristics, and generic design. The classification is requisite to ensure that the corresponding principle is itemised, based on its characteristic suitability. To understand the functions of terminology as described in Table 2, the definition of each related element is given as follows:

- i. DFAM: Highly relevant in designing the part for AM, based on design freedom
- ii. AMPD: Highly recommended for a process-relevant characteristic that can be applied to existing AM processes
- iii. Generic design: Can be applied in design of any part that is being developed under specific conditions and is not only limited to AM processes

Table 2 Customization of the classical TRIZ and modified TRIZ-AM definitions

| No | Principle | Classical TRIZ definition | Modified TRIZ-AM definition | DFAM | AMPD | Generic design |
|----|-------------------------|---|---|------|------|----------------|
| 1 | Segmentation | <ul style="list-style-type: none"> Dividing a system or object into independent parts Increasing the degree of segmentation of an object or system | <ul style="list-style-type: none"> The component is divided into smaller pieces in the CAD system if the component is bigger than the build platform to improve manufacturability | X | X | |
| 2 | Taking out | <ul style="list-style-type: none"> Separating an interfering part or property from an object | <ul style="list-style-type: none"> Trimming or reducing unnecessary parts, such as thick walls and hollow interiors, can reduce time and minimise weight | X | | |
| 3 | Local quality | <ul style="list-style-type: none"> Changing the structure of an object from uniform to non-uniform Making different parts of objects perform different functions | <ul style="list-style-type: none"> Generation of cellular structures (non-uniform), such as scaffolding structures in medical applications | X | | |
| 4 | Asymmetry | <ul style="list-style-type: none"> Using non-uniformity, especially in a geometrical sense, but it could also be in time or sequences. If an object is already asymmetrical, increasing its degree of asymmetry | <ul style="list-style-type: none"> Anisotropic structures; designing the parts by considering the build orientation, especially for load-bearing parts for FDM | X | X | |
| 5 | Merging | <ul style="list-style-type: none"> Bringing closer together identical or similar objects, assembling identical or similar parts to perform parallel operations | <ul style="list-style-type: none"> Part consolidation. A system or mechanism that can be used without further assembly. Main purpose is to consolidate the parts for better functional performance and to reduce assembly time | X | | |
| 6 | Universality | <ul style="list-style-type: none"> Making a part or object perform multiple functions Eliminating the need for another component or parts | <ul style="list-style-type: none"> Performing multiple functions by adding the functional features in standard components, such as gas turbine blade with cooling ducts | X | | |
| 7 | Nested-doll | <ul style="list-style-type: none"> Placing one object inside another; placing each object, in turn, inside the other | <ul style="list-style-type: none"> Designing interlocking mechanism or feature into parts will provide a more permanent bond between the components | X | | |
| 8 | Anti-weight | <ul style="list-style-type: none"> Compensating for the weight of an object by merging or lifting the weight | <ul style="list-style-type: none"> Replacing the solid volumes and surfaces with cellular structures, such as honeycomb lattice | X | | |
| 9 | Preliminary anti-action | <ul style="list-style-type: none"> If an action is necessary, using both harmful and useful effects, this action should be replaced with anti-actions to control harmful effects | <ul style="list-style-type: none"> Maintain classic definitions | | | X |

Table 2 Customization between classical TRIZ and modified TRIZ-AM definitions (Continued)

| No | Principle | Classical TRIZ definition | Modified TRIZ-AM definition | DFAM | AMPD | Generic design |
|----|------------------------|--|---|------|------|----------------|
| 10 | Preliminary action | <ul style="list-style-type: none"> Perform, before it is needed, the required change of an object or system (either fully or partially) Locate objects in the most convenient places to avoid lost time during their delivery | <ul style="list-style-type: none"> Design an object with features easily post-processed otherwise it will affect the actual design and shape. For example, producing holes using FDM may have an outcome such as burrs if the hole is too small; it is difficult to remove burrs | X | | |
| 11 | Beforehand cushioning | <ul style="list-style-type: none"> Prepare emergency means in advance to compensate for the relatively low reliability of an object or system | <ul style="list-style-type: none"> Design parts that can easily be substituted temporarily when there is a shortage of parts or tools for replacement, such as jigs and fixtures in production lines and the rapid production of spare parts on ships | X | | |
| 12 | Equipotentiality | <ul style="list-style-type: none"> In a potential field, limit position changes (e.g., change operating conditions to eliminate need to raise or lower objects in a gravity field). | <ul style="list-style-type: none"> Maintain classical definition | | | X |
| 13 | The other way around | <ul style="list-style-type: none"> Invert the action(s) used to solve the problem (e.g., instead of cooling an object, heat it) Make movable parts (or the external environment) fixed, and fixed parts movable) Turn the object (or process) 'upside down' | <ul style="list-style-type: none"> Design parts with non-uniform wall thicknesses to improve efficiency. For example, graded hexagonal structure to improve part functionality. This differs from injection moulding where only uniform wall thickness can be manufactured. | X | X | |
| 14 | Speriodality/curvature | <ul style="list-style-type: none"> Flat surfaces to spherical ones; parts shaped as a cube (parallelepiped) to ball-shaped structures Instead of using rectilinear parts, surfaces, or forms, use curvilinear ones; change flat Use rollers, balls, spirals, domes Change from linear to rotary motion, use centrifugal forces | <ul style="list-style-type: none"> Design lighter, more organic and aesthetically unique-looking products using topology optimisation (TO) methods | X | | |
| 15 | Dynamics | <ul style="list-style-type: none"> Allow (or design) the characteristics of an object, external environment, or process to change to be optimal or to find an optimal operating condition. Divide an object or system into parts capable of movement relative to each other | <ul style="list-style-type: none"> The design can be customised according to its natural behaviour in controlled conditions, such as prosthetic hands Allow movement with interconnected parts | X | | |

Table 2 Customization between classical TRIZ and modified TRIZ-AM definitions (Continued)

| No | Principle | Classical TRIZ definition | Modified TRIZ-AM definition | DFAM | AMPD | Generic design |
|----|------------------------------|---|---|------|------|----------------|
| 16 | Partial or excessive action | <ul style="list-style-type: none"> If 100 percent of an objective is hard to achieve using a given method then, by using 'slightly less' or 'slightly more' of the same method, the problem may be considerably easier to solve | <ul style="list-style-type: none"> Maintain classic definitions | | | X |
| 17 | Other dimensions | <ul style="list-style-type: none"> Use a multi-story arrangement of objects instead of a single-story arrangement Move an object or system in two- or three-dimensional space Tilt or re-orient the object or system, lay it on its side Use 'another side' of a given area | <ul style="list-style-type: none"> Designing parts with multi-functional artefact involving multi-scale structure Multiscale structure consists of micro, meso and macro scales Micro scale (<0.1mm), meso- scale (0.1-10mm), macro scale (>10mm) | X | | |
| 18 | Mechanical vibrations | <ul style="list-style-type: none"> Cause an object or system to oscillate or vibrate Increase its frequency (even up to the ultrasonic) Use an object- or system-resonant frequency Use piezoelectric vibrators instead of mechanical ones | <ul style="list-style-type: none"> Maintain classical definition | | | X |
| 19 | Periodic actions | <ul style="list-style-type: none"> Instead of continuous action, use periodic or pulsating actions If an action is already periodic, change the periodic magnitude or frequency Use pauses between impulses to perform a different action | <ul style="list-style-type: none"> Maintain classic definition | | | X |
| 20 | Continuity of useful actions | <ul style="list-style-type: none"> Carry on work continuously; make all parts of an object or system work at full load, all the time Eliminate all idle or intermittent actions or work | <ul style="list-style-type: none"> Maintain classical definition | | | X |
| 21 | Skipping | <ul style="list-style-type: none"> Conduct a process, or certain stages (e.g., destructive, harmful or hazardous operations) at high speed | <ul style="list-style-type: none"> Maintain classical definition | | | X |
| 22 | Blessing in disguise | <ul style="list-style-type: none"> Eliminate the primary harmful action by adding it to another harmful action to resolve the problem Use harmful factors (particularly, harmful effects of the environment or surroundings) to achieve a positive effect | <ul style="list-style-type: none"> The staircase effects in the printed part will produce rough surfaces and it might be beneficial for some applications that require them, e.g., for higher friction force Designing multiple short overhangs to prevent falling off layers | X | X | |

Table 2 Customization between classical TRIZ and modified TRIZ-AM definitions (Continued)

| No | Principle | Classical TRIZ definition | Modified TRIZ-AM definition | DFAM | AMPD | Generic design |
|-----|----------------------------|---|---|------|------|----------------|
| 23 | Feedback | <ul style="list-style-type: none"> Introduce feedback (referring back, cross-checking) to improve a process or action | <ul style="list-style-type: none"> Maintain classic definitions | | | X |
| 24* | Intermediary | <ul style="list-style-type: none"> Use an intermediary carrier article or intermediary process Merge one object temporarily with another (that can be easily removed) | <ul style="list-style-type: none"> Use removable built plate for the bed platform, such as magnetic bed in FDM, to ease the procedure of taking off the printed part | | X | |
| 25 | Self-service | <ul style="list-style-type: none"> Make an object or system serve itself by performing auxiliary helpful functions Use waste (or lost) resources, energy, or substances. | <ul style="list-style-type: none"> Personalise parts by customised design, e.g., additional text, colour and decoration with batch, or single production of keychain and souvenirs at low cost | X | | |
| 26 | Copying | <ul style="list-style-type: none"> Instead of an unavailable, expensive, or fragile object or system, use simpler inexpensive copies Replace an object or system with optical copies | <ul style="list-style-type: none"> Maintain classical definitions | | | X |
| 27 | Cheap, short-lived objects | <ul style="list-style-type: none"> Replace an expensive object with a multiple of inexpensive objects, compromising certain qualities, such as service life | <ul style="list-style-type: none"> Designing parts that can be used as emergency spare parts for easier maintenance purposes | X | | |
| 28 | Mechanics substitution | <ul style="list-style-type: none"> Replace a mechanical means with a sensory (optical, acoustic, taste or smell) means | <ul style="list-style-type: none"> New ways of integrating identification of components, such as 3D printed insoles | X | | |
| 29 | Pneumatics and hydraulics | <ul style="list-style-type: none"> Use gas and liquid parts of an object or system instead of solid parts (e.g., inflatable, filled with liquids, air cushion, hydrostatic, hydro-reactive) | <ul style="list-style-type: none"> Maintain classic definitions | | | X |
| 30 | Flexible and thin shells | <ul style="list-style-type: none"> Use flexible shells and thin films instead of three-dimensional structures Isolate the object or system from the external environment using flexible shells and thin films | <ul style="list-style-type: none"> Maintain classic definitions | | | X |
| 31 | Porosity | <ul style="list-style-type: none"> Make an object or system porous or add porous elements (inserts, coatings, etc.) | <ul style="list-style-type: none"> Replace internal structure with lattice structure to reduce weight and material cost | X | | |
| 32 | Colour changes | <ul style="list-style-type: none"> Change the colour of an object or its external environment | <ul style="list-style-type: none"> Convey information about parts with colour coding. For example, a casing with a different colour, such as purple for top cover and orange for base | | X | |

Table 2 Customization between classical TRIZ and modified TRIZ-AM definitions (Continued)

| No | Principle | Classical TRIZ definition | Modified TRIZ-AM definition | DFAM | AMPD | Generic design |
|-----|---------------------------|---|---|------|------|----------------|
| 33* | Homogeneity | <ul style="list-style-type: none"> Make objects interact with a given object of the same material (or material with identical properties) | <ul style="list-style-type: none"> 3D printed abrasive tools can be used for post-processing purposes to improve surface finish of 3D printed metal parts | | X | |
| 34 | Discarding and recovering | <ul style="list-style-type: none"> Remove portions of an object or system that have fulfilled their functions, or modify them directly during operation Conversely, restore consumable parts of an object or system directly in operation | <ul style="list-style-type: none"> Remove the sharp edges in a design for better accuracy Design round edges to increase the surface area and prevent warping effects | X | X | |
| 35* | Parameter change | <ul style="list-style-type: none"> Change an object's physical state (e.g., to a gas, liquid, or solid) Change the concentration or consistency Change the temperature | <ul style="list-style-type: none"> Use flexible filaments to produce parts that can be easily stretched or bent, such as TPE or TPU materials. Solid parts can be made from powder materials such as LPBF processes | | X | |
| 36 | Phase transitions | <ul style="list-style-type: none"> Use of volume or other physical properties | <ul style="list-style-type: none"> Maintain classical definition | | | X |
| 37 | Thermal expansion | <ul style="list-style-type: none"> Use thermal expansion (or contraction) of materials If thermal expansion is being used, use multiple materials with different coefficients of thermal expansion | <ul style="list-style-type: none"> Multi-materials produce colour combinations and tones without need for post-painting. Translucent and rigid parts can be produced in single printing productions | | X | |
| 38 | Strong oxidants | <ul style="list-style-type: none"> Replace common air with oxygen-enriched air (enriched atmosphere) Replace enriched air with pure oxygen (highly enriched atmosphere) Expose air or oxygen to ionising radiation | <ul style="list-style-type: none"> Maintain classic definitions | | | X |
| 39 | Inert atmosphere | <ul style="list-style-type: none"> Replace a normal environment with an inert one Add neutral parts or inert additives to an object or system | <ul style="list-style-type: none"> Maintain classic definitions | | | x |
| 40 | Composite materials | <ul style="list-style-type: none"> Change from uniform to composite (multiple) structures | <ul style="list-style-type: none"> Use composite materials to enhance the mechanical properties, such as CFRP or wood for aesthetic value, abrasive particles for the grinding performance | | X | |

4.2 Illustrative Case Study Using TRIZ-AM Cards

In support of utilisation of modified TRIZ-AM, especially for new AM designers, TRIZ-AM cards are introduced as a design tool. The main motivation is to assist designers in creative thinking and process innovation related to AM product design and development activities. Tables 3 present the TRIZ-AM cards along with the relevant instructions. However, it is noteworthy that only 26 principles are introduced in order to demonstrate the modified TRIZ-AM, as described in Tables 2. The goals of the TRIZ-AM cards is to assist the designer reducing the potential of print failures, improve understanding of AM capability and limitation along with the technology revolution, and also suggested the suitable course of action. The TRIZ-AM cards are very easy to use because it contains the scenario to assist designer deeply into the actual situation and also gives and appropriate recommendations. It was particularly designed with additional considerations in mind that industry often will not adopt a new method unless it is practical to use. The TRIZ-AM cards are designed to be reminiscent of classical TRIZ cards and the purpose to do so is to aid industry adoption.

Table 3 TRIZ-AM Cards with redefined principle

| | | | |
|--|--|---|--|
| <p>TRIZ-AM P1:Segmentation</p>  <p>Design Process</p> <p>The component is divided into smaller pieces in cad if the component > the build platform to improve manufacturability</p> | <p>TRIZ-AM IP 1: Segmentation</p> <p>According to the definition, this principle asks the designer to divide the component into smaller pieces if the component is bigger than the expected build volume. For example, there is a rectangle with dimensions of 250 mm x 250 mm x 50 mm. If the build volume of the selected 3D printer is only 200 mm for x, y and z perimeter, it is advised to break the rectangle pieces into fragments that can fit the build volume.</p> | <p>TRIZ-AM P2:Taking Out</p>  <p>Design</p> <p>Trimming or reducing unnecessary parts, such as thick walls and hollow interiors, can reduce time and minimise weight</p> | <p>TRIZ-AM IP 2: Taking out</p> <p>According to the definition, this principle asks the designer to reduce and trim unnecessary items in the design, such as thick walls, and replace the solid with a hollow interior. For example, a hinge can be designed with a solid surface outside but have a hollow interior inside. And it is possible to manufacture using AM. As illustrated in the diagram, this principle allows the solid cube to be trimmed into a hollow cube while still maintaining the actual dimensions of the structure.</p> |
| <p>TRIZ-AM P3:Local Quality</p>  <p>Design</p> <p>Generation of cellular structure (non-uniform) such as for scaffold structure in medical applications</p> | <p>TRIZ-AM IP 3: Local quality</p> <p>According to the definition, this principle allows designers to generate a cellular structure in their design. This cellular structure is beneficial for tissue engineering applications in particular as it can create a lighter and stronger material for the part. 3D-printed scaffolding allows many cells to grow on a single implant. It can also be used to boost the repair of complex tissues like bone and cartilage.</p> | <p>TRIZ-AM P4:Asymmetry</p>  <p>Design Process</p> <p>Anisotropic structures: design the parts by considering the build orientation, especially for load-bearing parts for FDM</p> | <p>TRIZ-AM IP 4: Asymmetry</p> <p>This principle depends on the designer's AM process selection. Anisotropic is a condition in which the strength of the part varies in relation to its printing orientation. A 3D-printed object may have different elongations or stiffness in the X, Y and Z-directions. For example, a wrench can be printed using three different orientations; however, a designer need to know which design is suitable for placing on the top of the build platform so it does not molest the remaining parts.</p> |

Table 3 TRIZ-AM Cards with redefined principle (Continued)



| | | | |
|--|--|---|--|
| <p>TRIZ-AM P5: Merging</p>  <p>Design</p> <p>Part consolidation. A system or mechanism that can be used without further assembly</p> | <p>TRIZ-AM IP 5: Merging</p> <p>Merging is also known as part consolidation in AM. The concept is to reduce the number of parts used and, if possible, reduce the assembly. Compared with DFMA, these consolidated parts have complex structures and producing them with conventional manufacturing is not feasible. For example, there is no screw or assembly required for air ducts following the part consolidation (PC) process.</p> | <p>TRIZ-AM P6: Universality</p>  <p>Design</p> <p>Performing multiple functions by adding the functional features in standard components such as gas turbine blade with cooling ducts</p> | <p>TRIZ-AM IP 6: Universality</p> <p>This principle allows the designer to design parts that can perform multifunctional processes because faster production times can be obtained when the objects are merged. For example, components such as gas turbine blades with cooling ducts or holes can be printed using FDM or LPBF techniques.</p> |
| <p>TRIZ-AM P7: Nested-doll</p>  <p>Design</p> <p>Designing interlocking mechanism or feature into parts will provide a more permanent bond between the components</p> | <p>TRIZ-AM IP 7: Nested doll</p> <p>In this principle, AM technology allows the designer to combine interlocking parts using various 3D printing methods as well as material and colour. These interlocking parts can provide a more permanent bond between the components than conventional bonding using screws. Another example is the nested doll in a 3d printer 'ball-in-ball' design.</p> | <p>TRIZ-AM P8: Anti-weight</p>  <p>Design</p> <p>Replacing the solid volumes and surfaces with cellular structures such as honeycomb lattice</p> | <p>TRIZ-AM IP 8: Anti-weight</p> <p>The lattice structure is unique because it compromises micro-architecture with a network of nodes, beams and struts. Replacing the solid volume with lattice produces a good strength-to-weight ratio, desirable shock sound absorption while reduce the material consumption. The lattice structure is useful for aerospace applications. Lattice designs, such as honeycomb and Gyroid, are popular in 3D printing.</p> |

Table 3 TRIZ-AM Cards with redefined principle (Continued)

| | | | |
|--|--|--|--|
| <p>TRIZ-AM P10:Preliminary action</p>  <p>Design an object with features that can easily be post-processed, otherwise it will affect the actual designs and shapes.</p> | <p>TRIZ-AM IP 10: Preliminary actions</p> <p>Preliminary actions assist the designer to design parts for AM taking into consideration that a post-process of the part is expected to take place later because it is additively manufactured. To conduct post-processing easily, the designer must avoid elements such as sharp edges, too small hollows, and a closed gap. This is also to prevent the accuracy and shape from diminishing the actual functions of the part.</p> | <p>TRIZ-AM P11:Beforehand cushioning</p>  <p>Design parts that can easily be temporarily substituted when there is a shortage of parts or tools for replacement, such as a jig and fixture in the production line.</p> | <p>TRIZ-AM IP 11: Beforehand cushioning</p> <p>Prior cushioning assists the designer to design a part that can easily be a substitute when there is a supply shortage of parts or tools. For example, in manufacturing, when there is a jig or fixture improvement in the production line, the fastest way to avoid disruption to the output is by fabricating the 3D printed jig while waiting for the outsourced parts, because it has the same functionality. Another example is the rapid production of spare parts on ships or even the major systems on platforms or on offshore industrial installations that operate away from the home base at remote locations and are continuously moving.</p> |
| <p>TRIZ-AM P13:The other way around</p>  <p>Avoid designing features in the orientation that requires the support structures to preserve its surface finish and accuracy</p> | <p>TRIZ-AM IP 13: The other way around</p> <p>Using the other way around or inversion principle allows designers to think out of the box. It allows designers to reverse the conventional thinking of designing for subtractive parts. For example, designers can design the same parts with different wall thickness or non-uniform wall thickness, such as graded hexagonal structures to improve energy absorption. This differs from injection moulding in which only a uniform wall thickness can be manufactured.</p> | <p>P14:TRIZ-AM Speriodality/ Curvature</p>  <p>Designing with lighter, more organic and aesthetically unique looking product using topology optimization (TO) method</p> | <p>TRIZ-AM IP 14: Speriodality/ Curvature</p> <p>Topology optimisation (TO) is a keyword for this principle. The designer can choose to conduct the topology optimisation process to produce organic and aesthetically unique-looking products as illustrated in the diagram. TO is a unique tool for AM design. It is anticipated that TO functioning will maximise thickness – only where it is needed – , minimise mass and optimise materials.</p> |

Table 3 TRIZ-AM Cards with redefined principle (Continued)

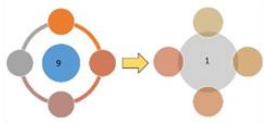
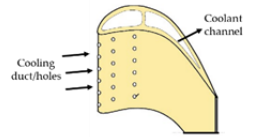
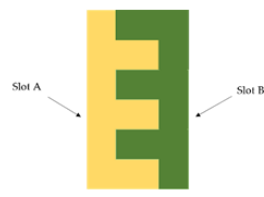
| | | | |
|---|---|--|---|
| <p>TRIZ-AM P15: Dynamics</p>  <p>Design</p> <p>Customized design according to its natural behavior in controlled conditions and allow movements with interconnected parts</p> | <p>TRIZ-AM IP 15: Dynamic</p> <p>Customised design freedom is offered by AM. In dynamic principle, it allows the designer to design the components according to natural behaviour or mimicry in controlled conditions, such as prosthetic hands.</p> | <p>TRIZ-AM P17: Another dimensions</p>  <p>Design</p> <p>Parts with multi-functional artefact; multi-scale structure, microscale/mesoscale/macro scale</p> | <p>TRIZ-AM IP 17: Another dimension</p> <p>Microstructure is any structure below 0.01 mm, mesoscale-structure is between 0.01-10.00 mm, and macro- scale is structure more than 10.00 mm. The designer can design the part using a multi-scale structure in a single component. For example, printed hollow polymer template-mediated with meso-scale and micro-scale can be used as a porous bone scaffold structure in tissue engineering.</p> |
| <p>TRIZ-AM P22: Blessing in disguise</p>  <p>Design Process</p> <p>The staircase effect above will provide a rough surface that may be beneficial in applications requiring it</p> | <p>TRIZ-AM IP 22: Blessing in disguise</p> <p>The staircase effect is the most crucial outcome for 3D printed parts, affecting the finishing of surfaces and producing rough surfaces. However, rough surfaces are becoming 'blessings in disguise' in certain applications, such as heat exchangers. This inventive principle uses the negative conditions in a positive way.</p> | <p>TRIZ-AM P24: Intermediary</p>  <p>Process</p> <p>Use removable built plates for bed platforms, such as magnetic beds in FDM, to ease the procedure of removing the printed part</p> | <p>TRIZ-AM IP 24: Intermediary</p> <p>The user is suggesting use of the removable built plate for bed platforms, such as magnetic platforms. Previously, a knife would have been used to peel off the 3D printed part resulting in damage if undue pressure were to be used.</p> |

Table 3 TRIZ-AM Cards with redefined principle (Continued)

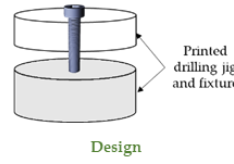
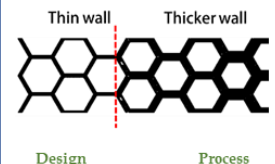

| | | | |
|--|--|---|---|
| <p>TRIZ-AM P25:Self-services</p>  <p>Design</p> <p>Personalise parts at low cost with design customisation; added text, colour and decoration, such as keychain and souvenir</p> | <p>TRIZ-AM IP 25: Self-services</p> <p>In any other conventional manufacturing, it is unfeasible or expensive to customise a design with decoration and added text. However, for this principle, the designer is free to customise a design with added text, decoration and specific colours, at low cost and in a short time with only a single fabrication. For example, a keychain and souvenir.</p> | <p>TRIZ-AM P27: Cheap short lived objects</p>  <p>Design</p> <p>Design a spare part that can be used for maintenance purposes in an emergency</p> | <p>TRIZ-AM IP 27: Cheap-short lived objects</p> <p>Spare-part 3D printing unlocks a new business model for manufacturers and suppliers. Printing spare parts rather than keeping them in an inventory can decrease cost and improve part availability through localised production, thus minimising dependency on the supply chain. Today, using this principle, spare parts can be designed to be practical, not too big and easy to store.</p> |
| <p>TRIZ-AM P28:Mechanic substitutions</p>  <p>Design</p> <p>New ways of integrated identification of components such as 3D printed insoles</p> | <p>TRIZ-AM IP 28: Mechanic substitution</p> <p>3D printed insoles provide a carbon copy of the athlete's own footprint, matching exact contours and pressure points. Presenting a perfect-fitting instantly, 3D printed insoles are flexible and fully breathable.</p> | <p>TRIZ-AM P31:Porosity</p>  <p>Design</p> <p>Replace internal structure with the lattice structure to reduce weight and material cost</p> | <p>TRIZ-AM IP 31: Porosity</p> <p>The designer can replace a solid volume with a lattice structure. The common lattice design, such as Gyroid and honeycomb, is mainly used in the industry to produce lightweight products and to increase their performance.</p> |

Table 3 TRIZ-AM Cards with redefined principle (Continued)

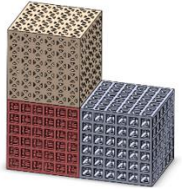
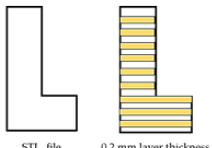
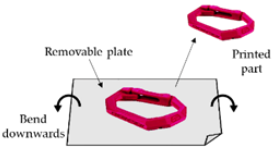

| | | | |
|---|---|---|---|
| <p>TRIZ-AM P32:Color changes</p>  <p>Top cover Base</p> <p>Process</p> <p>Convey information with colour coding. For example, a casing with different colours, such as purple for the top cover and orange for the base</p> | <p>TRIZ-AM IP 32: Colour change</p> <p>3D printing allows the designer to produce the part with different colour indications. This can be done with direct or indirect colour 3D printing. For example, FDM uses direct colour printing in which the colour is blended into the filament (material) and extruded to build the parts. Therefore, the designer can choose which colour to use on each respective component. For example, casing with two different colour codes to describe different functions.</p> | <p>TRIZ-AM P33:Homogeneity</p>  <p>Sintered metal powder Porous</p> <p>Powder flakes</p> <p>Process</p> <p>3D printed abrasive tools can be used for post-processing purposes to improve surface finishing of 3D printed metal parts</p> | <p>TRIZ-AM IP 33: Homogeneity</p> <p>Previously, conventional abrasive machining was used as a post-processing technique in metal 3D printing. Today, the trend in contemporary abrasive machining using innovative 3D printed abrasive tools is receiving much attention due to its potential. A 3D printed abrasive tool can produce a surface finish similar to that produced by CNC milling.</p> |
| <p>TRIZ-AM P34:Discarding and recovering</p>  <p>Design Process</p> <p>Design round edges to increase the surface area and preventing warping effects</p> | <p>TRIZ-AM IP 34: Discarding and recovering</p> <p>Designers should eliminate features such as sharp edges that are likely to be unsuccessful when printing, replacing them using round edges to prevent the parts from warping.</p> | <p>TRIZ-AM P35:Parameter changes</p>  <p>Easily to stretch and bending</p> <p>Process</p> <p>Use flexible filaments to produce parts that can be easily stretched and bent. Solid parts can also be made from powder materials, such as LPBF processes</p> | <p>TRIZ-AM IP 35: Parameter change</p> <p>Designers can use a combination of microstructure and texture when selecting suitable materials for applications; for example, using TPU and also TPE to produce parts that can be stretched and bent without requiring additional processes, such as for the production of plastic tyres for RC cars or children’s toys.</p> |

Table 3 TRIZ-AM Cards with redefined principle (Continued)

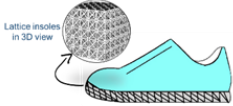
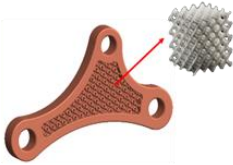
| | | | |
|--|--|--|---|
| <p>TRIZ-AM P37: Thermal expansion</p>  <p>Process</p> <p>Multi-materials produce colour combinations and tones without the need for post-painting. Translucent and rigid parts can be produced in a single printing.</p> | <p>TRIZ-AM IP 37: Thermal expansion</p> <p>Contrasting with the classical TRIZ definition, TRIZ-AM focusses on multi-material effects for this principle. Multi-material is not only produced in various colour combinations, but also has different functions and properties. For example, 3D prints on multiple silicon materials forming a homogenous surface with both soft and hard segments in a single printing.</p> | <p>TRIZ-AM P40: Composite material</p>  <p>Process</p> <p>Use composite materials in FDM to enhance the mechanical properties such as CFRP or Wood for aesthetic value</p> | <p>TRIZ-AM IP 40: Composite material</p> <p>The evolution of materials in recent years has resulted in increased use of composite materials, which can be used today in 3D printers to produce parts. Composite material available in AM, including carbon fibre and wood fibre, has been reinforced to the standard polymer to provide a superior function for printed parts. For example, printing with wood filaments can produce the texture and feel of actual wooden parts</p> |
|--|--|--|---|

4.2.1 Results from the Case Studies

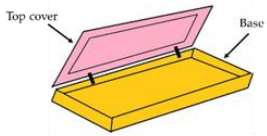
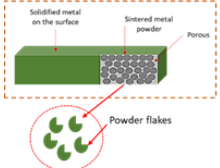
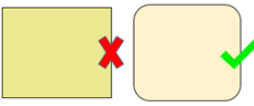
The effectiveness of the developed design approach was evaluated using two case studies and is presented as follows. The case studies results are analysed to gain a better understanding of the correlation between TRIZ-AM cards and total part reduction or design simplifications. Roll bar design is studied for the purpose of total part reductions, while the PCB casing redesign is investigated for the design simplifications.

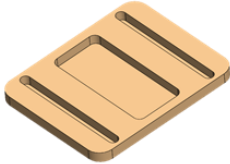
I. Case study 1-

The first case involved design of a roll bar for a hanging shelf – the original product design is presented in Table 4. The original design consists of 20 parts. With a focus on creativity, the designer's task was to redesign the product, reducing the number of parts as much as possible but, at the same time, enhancing the product's functions. The designer was then assigned to redesign the parts using the TRIZ-AM cards. The design sketch results are presented in Table 5.

Table 4 Case study 1: Original design of a roll bar consisting of 20 parts

| Original design | Bill of material |
|---|--|
|  | <ul style="list-style-type: none"> • Base plate (1x) • Roll bar (1x) • Flange (2x) • Bevel washer bottom (4x) • Bevel washer top (4x) • Nut (4x) • Screw (4x) <p>Total part counts : 20</p> |

Table 5 shows the illustrative results from the designer before and after using the TRIZ-AM cards. Overall, the designer managed to reduce the total part count from 20 to 14 parts using creativity alone, without using design tools. With experience and creativity, the designer managed to reduce the parts with an additional roll bar and accessories box for multiple functions. Overall, a 30% reduction of the part count in the original design was achieved. The re-design parts now consist of a base plate, roller bar, hinge, suction cup, accessories box, and also screw or connectors. Some observations were identified to evaluate the first redesign concept. Concept-wise, the original idea was to improve the area of the base plate, hence, a concept of a key-box holder was replaced with the existing base plate to upgrade the functions of the roll bar rack into a Do-It-Yourself (DIY) storage box.

At the first glance, the redesign mimics the slot concept where there are two long slits or narrow apertures located on both sides of the base plate. Designer portrays the creativity by translating the idea of roller bar rack into the multifunction rack without dismissing the original functionality. It has been observed that the designer uses the design concept of 'solid-based' at the base plate area. The designer adopted a traditional thinking style when designing the base plate area. This design can easily be made using the milling or injection moulding process. Meanwhile, the side of the base plate was designed with a thick, solid, and plain design. The idea is to produce the design with symmetrical components because it is easier to fabricate using subtractive manufacturing than the components that have radii and also curve. This may consumed unnecessarily material usage.

Table 5 Redesigned sketch result of case study 1 before and after using TRIZ-AM cards

| Before using TRIZ-AM cards | After using TRIZ-AM cards | |
|--|---|---|
|  |  | |
| <p>Part consisted of ;</p> <ul style="list-style-type: none"> • Base plate (1x) • Roller bar (3x) • Hinge (3x) • Screw and connectors (6x) • Accessories box (1x) <p>Total part counts : 14</p> | <p>Part consisted of ;</p> <ul style="list-style-type: none"> • Base embed with accessories box (1x) • Roller bar (3x) <p>Total part counts : 4</p> | <p>TRIZ-AM applied;</p> <ul style="list-style-type: none"> • #2-Taking out • #8-Anti-weight • #7-Nested doll • #40-Composite material |

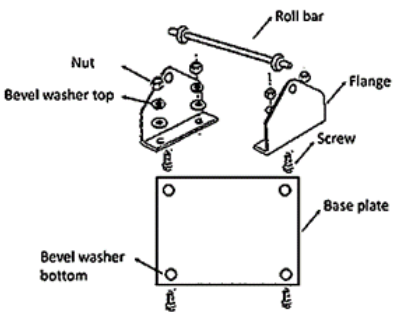
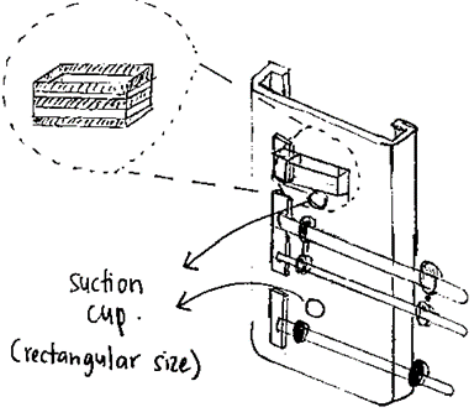
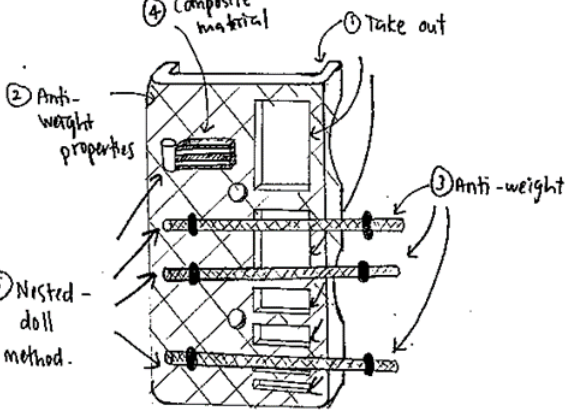
In addition, the designer still make use of screw and hinge to embed the roller bar on top of the base plate. Even though the use of these connectors can provide a strong bond to mate the components, there are other alternatives to combine them. The designer also added accessories box to improve the functions of the roller bar. However, at the very beginning, an accessories box was attached to the base plate using the same hinge concept as the roller bar. The attachment of the accessories box may add weight to the base plate and the idea to use a hinge can shorten the lifespan of the respective components.

When the TRIZ-AM cards were introduced, a more innovative and simplified design was produced with up to a 80%-part reduction compared with the original design. The TRIZ-AM IPs used include *#2-taking out*, *#8-anti-weight*, *#7-nested-doll* and *#40-composite material*. The *#taking out* in TRIZ-AM principle was used to reduce the usage of raw material by replacing the thick, solid, and plain design with a circular curve. In the design, the curve represents fluidity and it is used for decoration and also as a separator between design elements. Producing curve or circular curve design is almost impossible when using subtractive manufacturing, but it is easily done with AM. In AM, producing the part with identical features are no longer carries an explicit advantage. Therefore, the designer is free to replace the thick, rectangular shape by taking out unnecessary weight with a simplified curve or any spline design.

Similarly, IPs *#anti-weight* used honeycomb properties to replace the solid volume for the base plate, producing lighter but stronger parts. For TRIZ-AM anti-weight principle, the idea is to encourage and allow designers to replace the internal volume with a cellular structure such as lattice types. The honeycomb structure is among one of the favorable lattice designs in 3D printing. The use of honeycomb properties for the internal surfaces of the base plate will produce stiffness and light at the external surfaces. At the same time, it also facilitates energy absorption inside the base plate to avoid crashworthiness. The results for part count reduction were mainly contributed by the IPs *#nested-doll*, utilizing the concept of interlocking joints. Using the traditional design thinking, the designer continued to use the conventional method of connecting the roll bar using a hinge. However, this practice was later improved when the hinges,

was replaced with the interlocking joint concept consisting of slots. The nested-doll principle is beneficial for build preparation and assembly manufacturing in AM. The slot was designed on the base plate and can be engineered as one whole part using 3D printing. Similarly, the accessories box is embedded in the base plate for a single fabrication.

Among AM techniques, this component is ideally to be manufactured by laser powder bed fusion (LPBF) using powder materials or fused deposition modeling (FDM) using composite filaments. Consumer goods in the market comprised of variety of materials that possess different material behaviours and functionalities. Therefore, composite materials in AM are good in overcoming the anisotropic mechanical properties due to the interlayer bonding deficiencies. With that in mind, TRIZ-AM IPs of the composite material was selected for the final touch-up. In conclusion, the results clearly demonstrate that even an inexperienced AM designer can think additively when utilising the TRIZ-AM cards as a guide.

II. Case study 2-

This case study was conducted by an experienced designer using AM for prototyping. It was anticipated that the designers would already be working from the perspective of 'think additively' when the task to re-design the part for AM was assigned. Case study 2 involved the improvement of an original design of a PCB casing, as illustrated in Table 6. The instructions given in case study 1 were also provided for case study 2.

Table 6 Case study 2: Original design of PCB casing consist of 18 parts

| Original design | Bill of material |
|---|--|
|  | <ul style="list-style-type: none"> • Top casing (1x) • PCB-excluded as part count (standard component) • PCB case (1x) • Screw and connector (16x) <p>Total part counts : 18</p> |

Table 7 presents the redesign results of the PCB casing. The PCB case parts were significantly reduced from 18 to 2 parts using only the designer's creativity and experience in AM. One of the interesting features arising from the concept of 'thinking additively' was the replacement of the screw and connectors with the snap-fit concept, also known as interlocking joints in TRIZ-AM IPs, resulting in an 89 percent reduction in parts used. However, it was captivating to see the final output after utilising the TRIZ-AM cards. Overall, designer utilized the TRIZ-AM IPs of *#32-color change*, *#8-anti-weight*, *#31-porosity*, *#10-preliminary action*, *#6-Universality*, *#5-merging*, and *#40-composite material*.

The top cover was innovatively upgraded by utilising seven principles of TRIZ-AM. Overall, for the top cover, there is the addition of the heat sink and fin to integrate the cooling concept for the printed circuit boards. Function wise, this is to improve the

cooling strategies without any additional outsource and assembly parts. PCB board is extremely sensitive to heat. Without adequate airflow and heat removal, PCB will retain

Table 7 Redesigned sketch of case study 2 before and after using TRIZ-AM cards

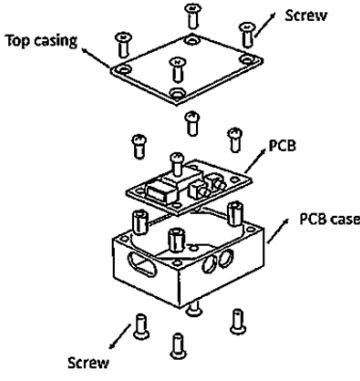
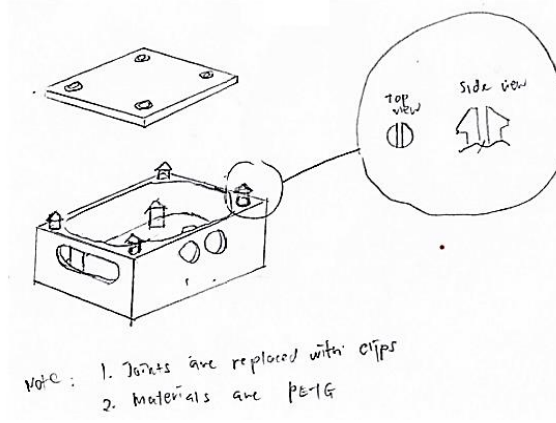
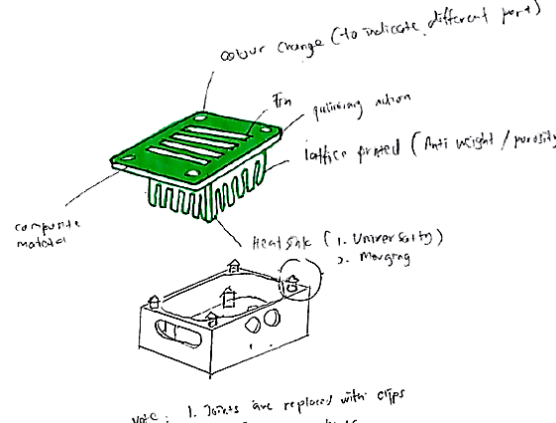
| Before using TRIZ-AM cards | After using TRIZ-AM cards | |
|--|---|---|
|  <p>Note: 1. Joints are replaced with clips 2. Materials are PETG</p> |  <p>Note: 1. Joints are replaced with clips 2. Materials are PETG</p> | |
| <p>Part consisted of ;</p> <ul style="list-style-type: none"> • Top cover • PCB case <p>Total part count: 2</p> | <p>Part consisted of ;</p> <ul style="list-style-type: none"> • Top cover with embedded heat sink and fin • PCB case <p>Total part count: 2</p> | <p>TRIZ-AM IPs applied;</p> <ul style="list-style-type: none"> • #5-Merging • #6-Universality • #8-Anti-weight • #10-Preliminary action • #31-Porosity • #32-Color change • #40-Composite material |

the heat and cause a gradual temperature increase leading to poor circuit performance or total damage. The designers applied the principle of #anti-weight, #porosity, #universality and #merging to improve this area. Instead of developing another heat sink, a lattice structure was used to replace the heat sink and acted like one, merging them with the top cover. This is the TRIZ-AM principle of universal concept that

designers need to keep in mind when designing for AM. The principle of #colour change was also applied to differentiate between the top cover and the PCB casing by conveying the information with the colour code. Use of this principle helps the user to determine which parts belong with each other and also to decorate the casing for an appealing design. Designers recommend to use PETG as the suitable material selection for the PCB case and top cover material because it has high strength mechanical parts while also being water, heat and chemical-resistant. Technical wise, these components are suitable to be manufactured using FDM technique. This is because the design feature does not contain thickness of less than 0.5 mm and also do not have any overhanging parts. The embedded lattice structure on the top cover may be seen overhanging, but, it can be successfully printed by adjusting the build orientation during the sample preparation stage. In conclusions, case study 2 demonstrates that the TRIZ-AM IPs design approach is applicable to experienced AM designers, and is not limited to novices. This method allows enhancement of the creativity level, enabling designers to think 'outside-the-box' rather than following the usual design practice.

4.2.2 Efficacy of Modified TRIZ-AM in Assisting Product Design and Innovations

In order to demonstrate the efficacy of the findings, feedback and responses from nine industrial experienced designers were collected and analyzed. The designers were all having four to six years of working experience in new product introductions (NPI) with basic understanding of TRIZ. The feedback survey was designed in terms of participant's subjective perception categorised into two important sections; (i) Section A

– clarity of the modified TRIZ-AM method/cards and (ii) Section B - benefits indicator for modified TRIZ-AM method. In Section A, 7 questions are listed represented by C1, C2...C7, meanwhile, in Section B, nine questions of the benefits indicators were represented by B1, B2...B9. All of the participants are required to answer the questions on a scale from 1 (strongly disagree) to 5 (strongly agree). Results from the feedbacks were used to evaluate the applicability of the method to the need of the industry.

i. Section A - Clarity of TRIZ-AM Cards

- C1- The TRIZ-AM cards are specific for AM applicability?
- C2- Designer can understand the TRIZ-AM inventive principle (IPs) through the scenario and definitions?
- C3- TRIZ-AM cards is brief, but comprehensive?
- C4- Designer can use the TRIZ-AM cards as a tool to generate ideas to solve technical issues when designing for AM
- C5- The terms used in TRIZ-AM cards are understandable by target population?
- C6- The technical language uses in TRIZ-AM cards is minimal and easy to understand
- C7- TRIZ-AM cards are easy to apply?

ii. Section B - Benefits of TRIZ-AM cards for industry adoption

- B1- Designer can improve the producibility of AM parts after uses the TRIZ-AM cards?
- B2- TRIZ-AM cards help to reduce the number of parts and assembly in a components?
- B3- Designer can enhance the functionality of the product in a single component without separating them into another parts?
- B4- TRIZ-AM can solve the key problems and promote the development of related AM technologies using selected inventive principles (IPs)?
- B5- Through TRIZ-AM IPs, designer is able to produce lightweight design and reduce the uses of raw materials?
- B6- TRIZ-AM cards can speed up the concept generation of a product and helps to shorten the R&D process?
- B7- TRIZ-AM can increase the designer knowledge on AM process abilities such as the material options and process-guideline specifications?

- B8- Combination of TRIZ-AM IPs encourage the creative solutions to solve the design problems?
- B9- TRIZ-AM is helpful in assisting product design and development in the industry?

Firstly, as shown in Figure 3, majority (over 50%) of the participants agreed and strongly agreed that the TRIZ-AM cards have a high level of clarity. This means that the propositions, technical language, wording, and composition of the cards can be understood by the users. However, it can be seen that there are neutral responses obtained for C1 to C5 and C7 with a minor percentage of between 11.11% to 22.22% only.

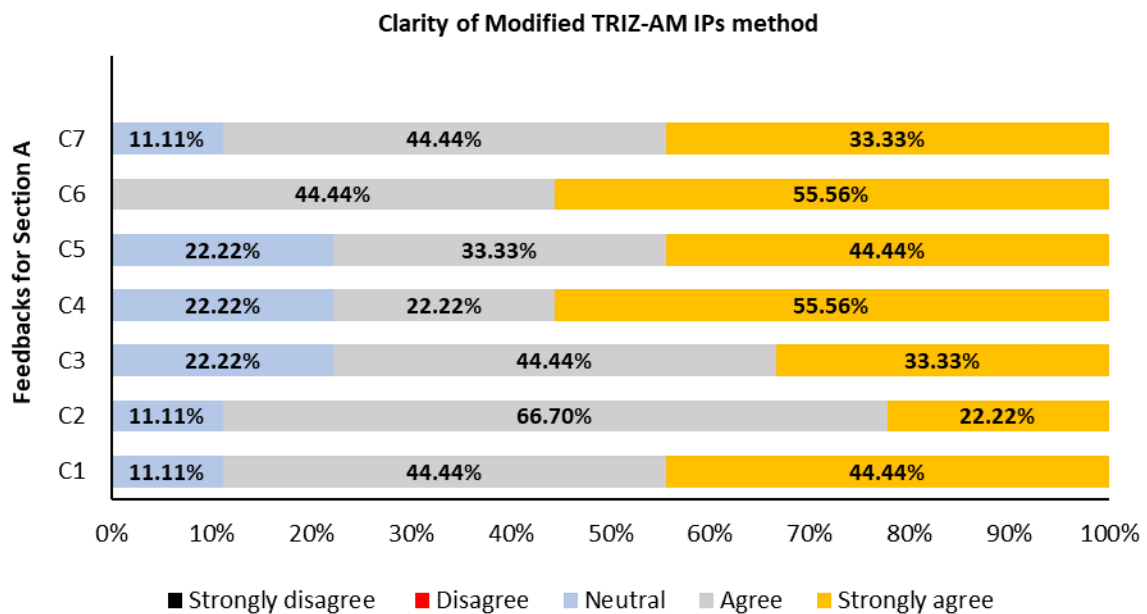

Fig. 3 Feedbacks percentage of clarity engagement of Modified TRIZ-AM method

Secondly, the feedback results of the Modified TRIZ-AM benefits are presented in Figure 4. All of the responses showed a positive support where the participants agreed and strongly agreed that the TRIZ-AM approach has the potential and benefits to be implemented in the industry. 78% of the respondents strongly agreed that the TRIZ-

AM method can greatly contribute to the product simplifications and able to reduce the total cost of the product design through the part reductions. The respondents also strongly agreed that the TRIZ-AM method able to reduce 66.67% of the material utilization for the end product. In addition, 78% of them also strongly agreed that the TRIZ-AM method has a potential in assisting product design and development in the industry.

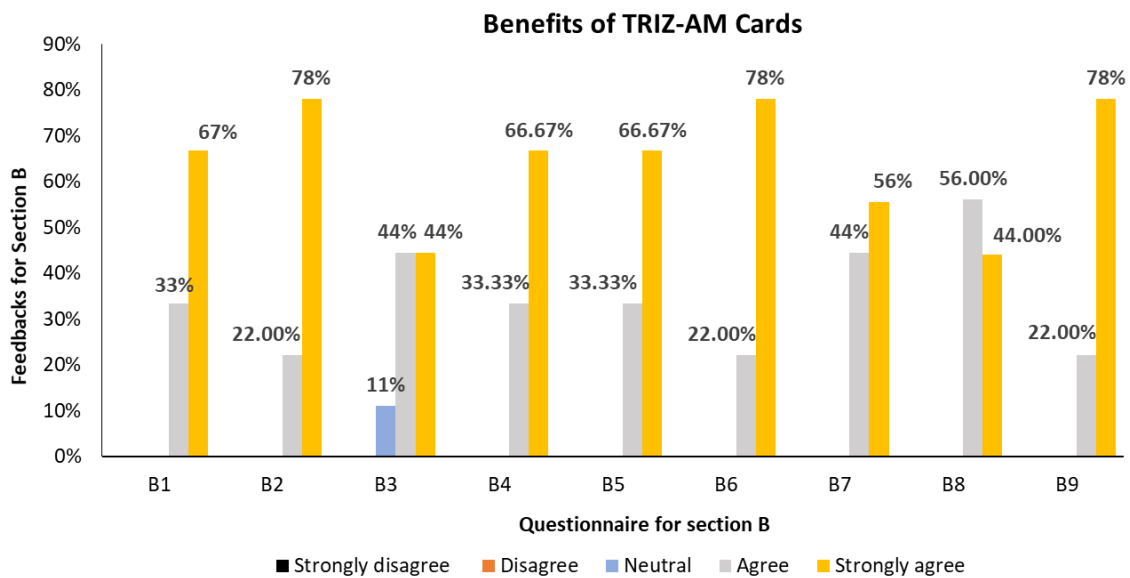

Fig. 4 Feedbacks percentage of potential benefits of Modified TRIZ-AM method

5. Conclusions and Future Work

This study introduces a new design approach, proposed as ‘Modified TRIZ-AM Inventive Principles (IPs)’, by enhancing the classical TRIZ IPs definition and instruction to suit AM applicability. The TRIZ inventive principles provide a design solution based on the design problem or problem statement. Previously, classical TRIZ has been combined with AM to reproduce the parts; however, it seems that the classical TRIZ with

contradiction matrix does not provide a clear design solution because the roadmap serves only specific problems. Therefore, this study introduces the new ideology of TRIZ within AM capabilities and complexity along with a solution in guiding technical creativity for designers.

In addition, TRIZ-AM cards are introduced as practical design tools consisting of instructions and images for graphical presentation and better understanding. In addition, two case studies were successfully conducted by industrial designers, one with AM-experience, while another doesn't have any experienced with AM. The results show that by using the TRIZ-AM cards, the designers reduced the total part count of the assembly product by 80% and 89%, respectively, using the illustrative TRIZ-AM cards concept. Both designers agreed that this design approach can generate more ideas relating to the design perspective. Furthermore, the evaluation feedbacks obtained from industrial practitioners confirmed the potential and effectiveness of the newly developed method, where 78% of the respondents strongly agreed that TRIZ-AM is helpful in assisting product design and development in the industry, meanwhile, more than 50% of respondents are agreed on the clarity and engagement of the TRIZ-AM cards. It showed that, the proposed method simplifies the design process in terms of time, cost and weight, and prevents the repetitive design iteration. It can also be useful for the promotion of AM capabilities to young and professional designers based on TRIZ-AM design practice.

The aim of this study is to enhance development by adding a decision support system to assist the designer to select suitable principles from TRIZ-AM cards as well as

performing intervention studies for wider range of participants' background for future work. This idea development is expected to generate interest from both designers and industry because generative design can be produced easily and save a lot of time during the design process. Dissemination of the developed method in the industry will demonstrate its practical application.

Acknowledgement

The authors would like to thank Universiti Teknologi Malaysia (UTM) R&D grant VOT 4J508 and UTM-ZAMALAH scholarship for providing the funding for this study.

References

- [1] Deja, M., and Siemiatkowski, M. S., 2018, "Machining Process Sequencing and Machine Assignment in Generative Feature-Based CAPP for Mill-Turn Parts," *J. Manuf. Syst.*, **48**(June), pp. 49–62.
- [2] Kleer, R., Weller, C., Kleer, R., and Piller, F. T., 2015, "Economic Implications of 3D Printing : Market Structure Models in Light of Additive Manufacturing Revisited *Int . J . Production Economics Economic Implications of 3D Printing : Market Structure Models in Light of Additive Manufacturing Revisited,*" *Intern. J. Prod. Econ.*, **164**, pp. 43–56.
- [3] Wiberg, A., Persson, J., and Ölvander, J., 2019, "Design for Additive Manufacturing – a Review of Available Design Methods and Software," *Rapid Prototyp. J.*, **25**(6), pp. 1080–1094.
- [4] Adam, G. A. O., and Zimmer, D., 2014, "Design for Additive Manufacturing- Element Transitions and Aggregated Structures," *CIRP J. Manuf. Sci. Technol.*, **7**(1), pp. 20–28.
- [5] Pradel, P., Zhu, Z., Bibb, R., and Moultrie, J., 2018, "A Framework for Mapping

- Design for Additive Manufacturing Knowledge for Industrial and Product Design,” *J. Eng. Des.*, **29**(6), pp. 291–326.
- [6] Tang, Y., and Zhao, Y. F., 2016, “A Survey of the Design Methods for Additive Manufacturing to Improve Functional Performance,” *Rapid Prototyp. J.*, **22**(3), pp. 569–590.
- [7] Booth, J. W., Alperovich, J., Chawla, P., Ma, J., Reid, T. N., and Ramani, K., 2017, “The Design for Additive Manufacturing Worksheet,” *J. Mech. Des. Trans. ASME*, **139**(10), pp. 1–3.
- [8] Deja, M., Dobrzyński, M., Flaszynski, P., Haras, J., and Zieliński, D., 2018, “Application of Rapid Prototyping Technology in the Manufacturing of Turbine Blade with Small Diameter Holes,” *Polish Marit. Res.*, **25**(s1), pp. 119–123.
- [9] Mokhtarian, H., Coatanéa, E., Paris, H., Mbow, M. M., Pourroy, F., Marin, P. R., Vihinen, J., and Ellman, A., 2018, “A Conceptual Design and Modeling Framework for Integrated Additive Manufacturing,” *J. Mech. Des. Trans. ASME*, **140**(8), pp. 1–13.
- [10] Deja, M, Siemiatkowski, S, S and Zielinski, D., 2020, “Multi Criteria Comparative Analysis of the Use of Subtractive and Additive Technologies in the Manufacturing of Offshore Machinery Components,” *Sciendo*, **27**(3), pp. 71–81.
- [11] Lin, S. Y., and Wu, C. T., 2016, “Application of TRIZ Inventive Principles to Innovate Recycling Machine,” *Adv. Mech. Eng.*, **8**(5), pp. 1–8.
- [12] Ilevbare, I. M., Probert, D., and Phaal, R., 2013, “A Review of TRIZ, and Its Benefits and Challenges in Practice,” *Technovation*, **33**(2–3), pp. 30–37.
- [13] Lin, Y. S., and Chen, M., 2021, “Implementing TRIZ with Supply Chain Management in New Product Development for Small and Medium Enterprises,” *Processes*, **9**(4), pp. 1–15.
- [14] Spreafico, C., and Russo, D., 2016, “TRIZ Industrial Case Studies: A Critical Survey,” *Procedia CIRP*, **39**, pp. 51–56.
- [15] Renjith, S. C., Park, K., and Okudan Kremer, G. E., 2020, “A Design Framework for Additive Manufacturing: Integration of Additive Manufacturing Capabilities in the

- Early Design Process,” *Int. J. Precis. Eng. Manuf.*, **21**(2), pp. 329–345.
- [16] Kretzschmar, N., and Chekurov, S., 2018, “The Applicability of the 40 TRIZ Principles in Design for Additive Manufacturing,” *Ann. DAAAM Proc. Int. DAAAM Symp.*, **29**(1), pp. 888–893.
- [17] Kamps, T., Gralow, M., Schlick, G., and Reinhart, G., 2017, “Systematic Biomimetic Part Design for Additive Manufacturing,” *Procedia CIRP*, **65**, pp. 259–266.
- [18] Motyl, B., and Filippi, S., 2020, “Investigating the Relationships Between Additive Manufacturing and TRIZ: Trends and Perspectives,” *Lect. Notes Mech. Eng.*, **1**, pp. 903–911.
- [19] Floriane, L., Frédéric, S., Gianluca, D. A., and Marc, L. C., 2017, “Enriching Design with X through Tailored Additive Manufacturing Knowledge: A Methodological Proposal,” *Int. J. Interact. Des. Manuf.*, **11**(2), pp. 279–288.
- [20] Boyard, N., Christmann, O., Richir, S., Boyard, N., Christmann, O., and Richir, S., 2013, “A Design Methodology for Parts Using Additive Manufacturing,” *Int. Conf. Adv. Res. Virtual Rapid Prototyp.*, p. 6.
- [21] Prabhu, R., Miller, S. R., Simpson, T. W., and Meisel, N. A., 2020, “Complex Solutions for Complex Problems? Exploring the Role of Design Task Choice on Learning, Design for Additive Manufacturing Use, and Creativity,” *J. Mech. Des. Trans. ASME*, **142**(3), pp. 1–12.
- [22] Horst, D., Duvoisin, C., and Vieira, R., 2018, “Additive Manufacturing at Industry 4.0: A Review,” *Int. J. Eng. Tech. Res.*, **8**(8), pp. 3–8.
- [23] Briard, T., Segonds, F., and Zamariola, N., 2020, “G-DfAM: A Methodological Proposal of Generative Design for Additive Manufacturing in the Automotive Industry,” *Int. J. Interact. Des. Manuf.*, **14**(3), pp. 875–886.
- [24] Vayre, B., Vignat, F., and Villeneuve, F., 2012, “Designing for Additive Manufacturing,” *Procedia CIRP*, **3**(1), pp. 632–637.
- [25] Salonitis, K., 2016, “Design for Additive Manufacturing Based on the Axiomatic Design Method,” *Int. J. Adv. Manuf. Technol.*, **87**(1–4), pp. 989–996.
- [26] Maidin, S. Bin, Campbell, I., and Pei, E., 2012, “Development of a Design Feature

- Database to Support Design for Additive Manufacturing,” *Assem. Autom.*, **32**(3), pp. 235–244.
- [27] Rias, A. L., Bouchard, C., Segonds, F., Vayre, B., and Abed, S., 2017, “Design for Additive Manufacturing: Supporting Intrinsic-Motivated Creativity,” *Emotional Engineering, Vol.5*, pp. 99–115.
- [28] Dede, J. and Z., 2015, “Additive Layer Manufacturing, and Experimental Testing of an Air-Cooled Heat Sink,” *J. Mech. Des.*, **137**, pp. 111403–111410.
- [29] Schmelzle, J., Kline, E. V., Dickman, C. J., Reutzel, E. W., Jones, G., and Simpson, T. W., 2019, “(Re) Designing for Part Consolidation : Understanding the Challenges of Metal Additive Manufacturing,” *J. Mech. Des.*, **137**, pp. 1–12.
- [30] Klahn, C., Leutenecker, B., and Meboldt, M., 2014, “Design for Additive Manufacturing - Supporting the Substitution of Components in Series Products,” *Procedia CIRP*, **21**, pp. 138–143.
- [31] Rias, A. L., Bouchard, C., Segonds, F., and Abed, S., 2016, “Design for Additive Manufacturing: A Creative Approach,” *Proceedings of International Design Conference, DESIGN*, pp. 411–420.
- [32] Yang, S., Page, T., and Zhao, Y. F., 2019, “Understanding the Role of Additive Manufacturing Knowledge in Stimulating Design Innovation for Novice Designers,” *J. Mech. Des. Trans. ASME*, **141**(2), pp. 1–12.
- [33] Chekurov, S., Wang, M., Salmi, M., and Partanen, J., 2020, “Development, Implementation, and Assessment of a Creative Additive Manufacturing Design Assignment: Interpreting Improvements in Student Performance,” *Educ. Sci.*, **10**(6), pp. 1–17.
- [34] Prabhu, R., Bracken, J., Armstrong, C. B., Jablokow, K., Simpson, T. W., and Meisel, N. A., 2020, “Additive Creativity: Investigating the Use of Design for Additive Manufacturing to Encourage Creativity in the Engineering Design Industry,” *Int. J. Des. Creat. Innov.*, **8**(4), pp. 198–222.
- [35] Prabhu, R. Simpson, T.W, Miller, S.R and Meisel, A., 2021, “Fresh in My Minds! Investigating the Effects of the Order of Presenting Opportunistic and Restrictive

- Design for Additive Manufacturing Content on Student's Creativity," *J. Eng. Des.*, **32**(4), pp. 187–212.
- [36] Yang, S., Tang, Y., and Zhao, Y. F., 2015, "A New Part Consolidation Method to Embrace the Design Freedom of Additive Manufacturing," *J. Manuf. Process.*, **347**, pp. 1–14.
- [37] Crispo, L and Kim, I., 2021, "Part Consolidation for Additive Manufacturing:A Multi-Layered Topology Optimization Approach," *Int. J. Numer. Methods Eng.*, **122**(18), pp. 4987–5027.
- [38] Jankovics, D., Barari, A., Jankovics, D., Barari, A., Jankovics, D., Barari, A., and Barari, A., 2019, "Customization of Automotive Structural Components Using Additive Manufacturing and Topology Optimization," *IFAC-PapersOnLine*, Elsevier Ltd, pp. 212–217.
- [39] Reichwein, J., Vogel, S., Schork, S., and Kirchner, E., 2020, "On the Applicability of Agile Development Methods to Design for Additive Manufacturing," *Procedia CIRP*, Elsevier B.V., pp. 653–658.
- [40] Vaneker, T., Bernard, A., Moroni, G., Gibson, I., and Zhang, Y., 2020, "Design for Additive Manufacturing: Framework and Methodology," *CIRP Annals*, Elsevier Ltd, pp. 578–599.
- [41] Haruna, A., and Jiang, P., 2020, "A Design for Additive Manufacturing Framework: Product Function Integration and Structure Simplification," *IFAC-PapersOnLine*, Elsevier Ltd, pp. 77–82.
- [42] Renjith, S. C., Okudan Kremer, G. E., and Park, K., 2018, "A Design Framework for Additive Manufacturing through the Synergistic Use of Axiomatic Design Theory and TRIZ," *IISE Annu. Conf. Expo 2018*, (May), pp. 551–556.
- [43] Gross, J., Park, K., and Okudan Kremer, G. E., 2018, "Design for Additive Manufacturing Inspired by TRIZ," *Proc. ASME Des. Eng. Tech. Conf.*, **4**(August).
- [44] Yuan, H., Xing, K., and Hsu, H. Y., 2019, "Generate Basic Conceptual Solutions for 3DPVS via Utilizing TRIZ," *Bio-Design Manuf.*, **2**(2), pp. 76–95.
- [45] Mawale, M. B., Kuthe, A., Mawale, A. M., and Dahake, S. W., 2018, "Development

of an Ear Cap in Chronic Suppurative Otitis Media Using Additive Manufacturing and TRIZ,” Proc. Inst. Mech. Eng. Part H J. Eng. Med., **232**(7), pp. 733–738.

[46] Chang, T. Y., Lu, H. P., Luor, T. Y., and Wu, C. Y., 2018, “Research and Innovative Design of a Drawing Instrument - A Case Study of Dashed Line Pen,” Proc. 4th IEEE Int. Conf. Appl. Syst. Innov. 2018, ICASI 2018, (7), pp. 712–715.

[47] Bariani, P. F., Berti, G. A., and Lucchetta, G., 2004, “A Combined DFMA and TRIZ Approach to the Simplification of Product Structure,” Proc. Inst. Mech. Eng. Part B J. Eng. Manuf., **218**(8), pp. 1023–1027.

[48] Galati, M., and Minetola, P., 2020, “On the Measure of the Aesthetic Quality of 3D Printed Plastic Parts,” Int. J. Interact. Des. Manuf., **14**(2), pp. 381–392.

[49] Zulhasni, A. R., Nooh, A. B., Sarimah, M., and Yeoh, T. S., 2015, “TRIZ Business Improvement and Innovation Framework for Malaysian Small and Medium Enterprise,” Appl. Mech. Mater., **735**, pp. 349–353.

List of Tables

| | | |
|---------|--|----|
| Table 1 | Example of variation keywords and synonyms used for AM complexity and capability searching | 16 |
| Table 2 | Customization of the classical TRIZ and modified TRIZ-AM definitions | 19 |
| Table 3 | TRIZ-AM Cards with redefined principle | 25 |
| Table 4 | Case study 1: Original design of a roll bar consisting of 20 parts..... | 32 |
| Table 5 | Redesigned sketch result of case study 1 before and after using TRIZ-AM cards | 34 |
| Table 6 | Case study 2: Original design of PCB casing consist of 18 parts..... | 37 |
| Table 7 | Redesigned sketch of case study 2 before and after using TRIZ-AM cards... | 38 |

List of Figures

| | | |
|--------|--|----|
| Fig. 1 | Six steps to integrate the classical TRIZ definition into a modified TRIZ-AM IPs definition..... | 14 |
| Fig. 2 | The classification of modified TRIZ-AM into independent groups | 17 |
| Fig. 3 | Feedbacks percentage of clarity engagement of Modified TRIZ-AM method... | 41 |
| Fig. 4 | Feedbacks percentage of potential benefits of Modified TRIZ-AM method | 42 |