



Channel Impulse Response Measurements at mmWave Band in Office and Conference Rooms

Monika Drozdowska⁽¹⁾, Sławomir J. Ambroziak⁽²⁾, Krzysztof K. Cwalina⁽²⁾, Piotr Rajchowski⁽²⁾, and Narcis Cardona⁽¹⁾

(1) iTEAM Research Institute, Universitat Politècnica de València, València, Spain

(2) Faculty of Electronics, Telecommunications and Informatics, Gdańsk University of Technology, Gdańsk, Poland

Abstract

In this paper, the measurements of the channel impulse response at mmWave band in office and conference rooms are described. The central frequency is 27 GHz with a bandwidth of 400 MHz. The description of the used measurement stand and considered environments are presented. The initial analysis of the power delay profile, mean delay, and RMS delay spread allows preliminary conclusions to be drawn that there is a significant impact of the dimensions of the rooms on these parameters.

1 Introduction

For the 5G networks, new frequency bands, with center frequencies of 26 GHz and 28 GHz were introduced. Both channels, n258 and n257, contain the 27 GHz frequency in their spectrum [1]. This is why analyzing the 27 GHz frequency band is advantageous. Higher frequency introduces higher free-space path loss. Moreover, materials' electromagnetic properties are more significant and noticeable, especially higher reflective abilities compared to lower frequencies. It turns almost all objects into obstacles. It requires much more precise positioning between transmitters (Tx) and receivers (Rx). For the networks and services in 5G, the indoor environment has to be well defined.

Focusing on a very specific use case, that is, a conference room, we can assume that all Rxs should receive from the Tx the same data. That is why we can consider multi-user (MU) grouping to enhance the network's performance. To perform it in the best possible way, the Rxs within one group should not be correlated or should be correlated as little as possible. Thus, spatial correlation is an important aspect of environment analysis [2] [3]. The other aspect of the conference use case is the propagation environment. It can relate to small conference rooms, as well as large auditories. In order to understand if and how significant the influence of the environment on propagation is, we need to study its multipath properties [4] [5] [6].

The measurements of the channel impulse response (CIR) presented in this paper allowed for calculation of the power delay profile (PDP), the mean delay (MD) and the root mean square delay spread (RMS DS), which are frequently used to quantify the time dispersive properties of wide band multipath channels.

The rest of the paper is organized as follows: Section 2 describes the measurement stand, Section 3 the measurement environments, and finally, Section 4 the preliminary results. Section 5 concludes the paper.

2 Measurement Stand

Measurements have been performed with the Microwave Network Analyzer (MNA) Keysight N5227B [7], which is a core of the measurement stand presented in Figure 1. This device can realize measurements in the frequency band between 10 MHz and 67 GHz. During the performed studies, port 1 of the MNA acted as a Tx, while Ports 2-4 were Rxs. The MNA has been set up for the measurements of the scattering matrix parameters, i.e. S21, S31, and S41, in time domain, which may be considered as a CIRs for these channels.

For the Tx antenna, it was selected a double ridged horn antenna DRH67 [8], with 14 dBi gain and 16 dB return loss (RL) at 27 GHz. The half power beamwidth (HPBW) of Tx antenna at this frequency is 30° in both E- and H-planes. A set of three Ka-Band omnidirectional Rx antennas has been used. The selected type of Rx antenna is vertically polarised SAO-2734030345-KF-S1 [9], with 3.2 dBi gain, 15 dB RL and 78° HPBW in E-plane at 27 GHz.

In order to enable measurements for larger distances between antennas, four sets of radio frequency (RF) over fiber converters (RFoF), RFoF-40GHz-Q2-Mini [10], have been used. The RF/O unit (marked in Figure 1) converts RF signal to an optical one and the O/RF unit converts the optical signal back to RF. The two units are connected by the 30 m long optical fiber. All RF connections were done with a MWX061 cables [11]. It should be mentioned, that each RF-fiber cable tract (including RFoF converters) has an average power gain of 9 dB.

Before the measurements, the MNA was calibrated in order to properly compensate the delays and attenuation in the cable tracks from the S21, S31, and S41 parameters' values reported at its output. With the calibration step performed, the recorded CIRs correspond to the relative attenuation in between the power at the Tx antenna port and the output power of the Rx antenna ports, i.e. the system loss (SL) [12].

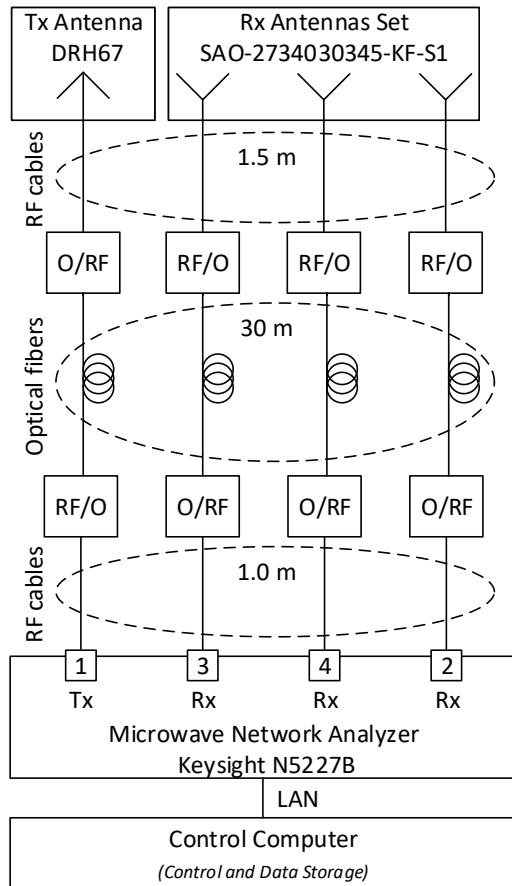

Figure 1. Block diagram of measurement stand.

The test signal with a bandwidth of 400 MHz was centered at 27 GHz. The MNA Tx power at Port 1 was set to 0 dBm. The Intermediate Frequency (IF) filter bandwidth of 100 kHz was used, yielding the average noise level of -97.7 dB (relative to the power fed to the Tx antenna). The MNA performed measurements by transmitting a short pulse at the Tx port, and simultaneously recording the response signal from the three Rx ports. The Tx pulse duration time was 4.89 ns, while the CIRs were recorded over a 250 ns delay window. In total 4001 sample points are obtained for each CIR, and 100 CIRs have been recorded for each channel and each scenario. The triggering time between successive CIR measurements was varying, being 201 ms in average. Since the MNA operates in the frequency domain, the Inverse Fourier Transform is performed to obtain the CIR from the measured Transfer Function of the channel. It should be mentioned that the Kaiser-Bessel window with shape parameter $\beta = 6$ was used in this process. All of the measurement parameters are summarised in Table 1.

The MNA was controlled via an Ethernet connection by a computer which also stored the measurement data on a local hard drive. The control software has been designed in G, the graphical programming language used in LabVIEW [13]. It allowed for automated measurement process and to collect over 3.9 GB of measurement data.

Table 1. Summary of the measurement parameters.

Measurement type	CIR
Tx power (port 1)	0 dBm
Center frequency	27 GHz
Bandwidth	400 MHz
IF Bandwidth	100 kHz
Tx pulse time	4.89 ns
CIR duration (max. delay)	250 ns
No. of samples per CIR	4001
Window function	Kaiser-Bessel ($\beta = 6$)
Average triggering time	201 ms

3 Measurement Environments

Measurements have been performed at Gdańsk University of Technology in three office rooms with different shapes and dimensions. The first one is NE 308 (Figure 2), which is a big conference room with seats for 90 people, with a length of 20.8 m and width 8.2 m. The height of the room is 3 m. The Tx antenna (red point) was mounted on the back wall of the room on its axis, and the Rx antennas (blue points) were placed in 50 points spread over the room.

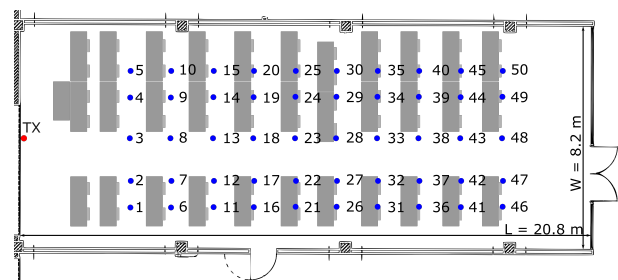

Figure 2. NE 308 measurement scenario.

The second investigated room is Aud 2 (Figure 3), which is an auditorium for 161 people, with the length of 16 m, width 12 m, and the height of 3.8 m (at the highest point). The Tx antenna was mounted in the middle of the wall in the lower part of the auditorium, while Rx antennas were placed in 63 points deployed in 7 rows. The last room under consideration is EA 427 (Figure 4). It is a typical small conference room for 20 people. Its length, width and height are 7.1 m, 4.5 m and 3 m, respectively. The Tx antenna was mounted in the middle of the wall, and Rx antennas were placed in 18 different points around the conference table.

In all cases the Tx and Rx antennas' heights over the floor were 2 m and 1 m, respectively. In addition, in order to ensure that Rx antennas are within the HPWB of the Tx antenna, it has been tilted by -15° in EA 427 and -12° in NE 308. Due to the construction of Aud 2 no tilt was required.

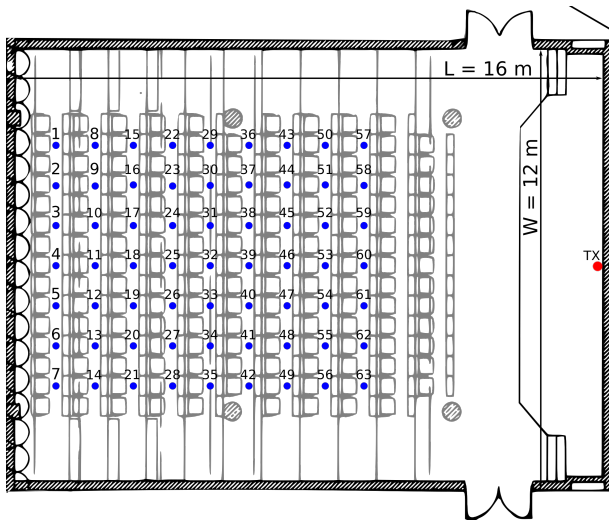

Figure 3. Aud 2 measurement scenario.

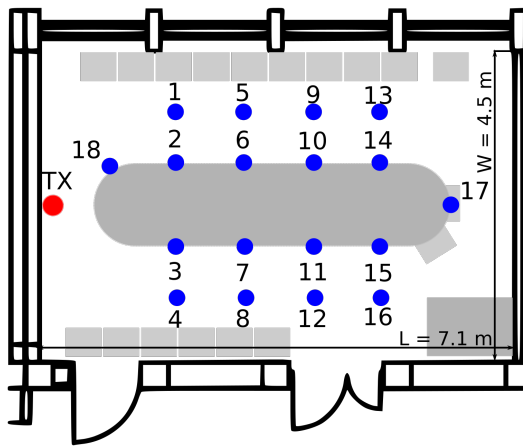

Figure 4. EA 427 measurement scenario.

4 Preliminary Results

Preliminary results of PDP, MD and RMS DS presented in this section were calculated based on the measured CIRs, with a 30 dB threshold below the peak level of the PDP.

In Figure 5, PDPs obtained from positions RX8 in NE 308, RX17 in EA 427 and RX60 in Aud 2 are shown. They are all placed in the axis of the main beam of the Tx antenna at distances around 6 m: 5.1 m, 5.8 m and 6.5 m, respectively. As expected, the dominant component arrives at a similar time since the distance between Tx and Rx in all rooms was similar. However, we can observe that signal received in the smallest room, EA 427, reaches the average noise level first, at 87 ns, which is the equivalent of 26 m, that is, around three times the diagonal of the room. For the Aud 2 these values are 150 ns and 45 m - 2.25 times the diagonal of the room. In the case of NE 308, the signal does not reach the average noise level in the observation time (250 ns, which is the equivalent of 3.57 times the length of the NE308's diagonal). The relation between the rooms' diagonal and the time needed for the signal to reach the average noise level will be further studied.

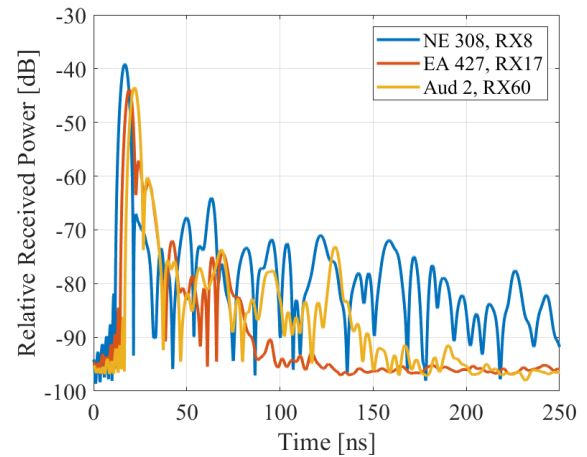

Figure 5. PDP of signal received in three rooms at the 6 m.

The dependence on the size of the room and the distances between Tx and Rx is also visible in Figures 6 and 7. For room EA 427 which was the smallest, both, the MD and the RMS DS are the smallest, so the larger the room, the larger the spread of obtained values. An interesting thing may be observed for the Aud 2: the MD statistical values, as presented in Figure 6, are much more similar to NE 308 than to EA 427 which was expected due to the dimensions of the rooms. Median values for MD are 15.4 ns, 37.4 ns, and 40.7 ns for EA427, Aud2, and NE308, respectively. However, the RMS DS values presented in Figure 7 are much closer to the values obtained in the smallest room. Median values for RMS DS are 4.3 ns, 7.1 ns, and 22.8 ns for EA427, Aud2, and NE308, respectively. Based only on the dimensions of the rooms it is an unexpected result. However, taking into account the aspect ratios of the environments, and the fact that floor of Aud2 has some slope, it has to be reconsidered what makes the most significant impact on the multipath propagation. Among other things, this will be the subject of future work.

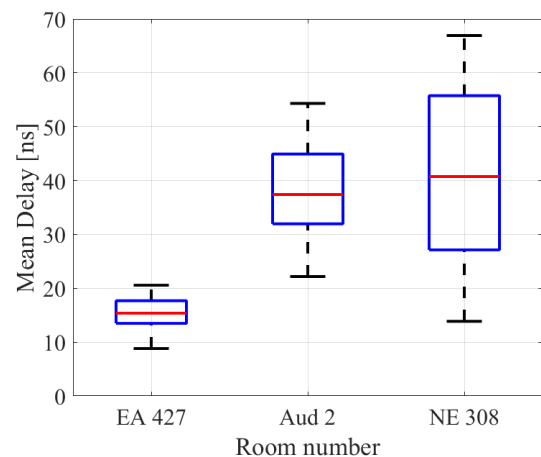

Figure 6. Mean delay for three rooms.

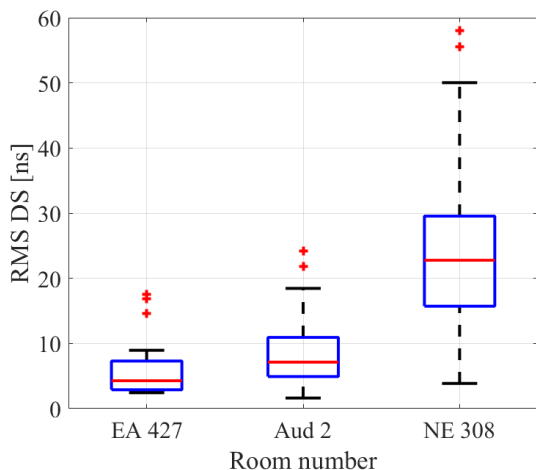

Figure 7. RMS DS for three rooms.

5 Conclusions

In the paper, the measurement stand for experimental investigations of radio channel properties at mmWave Band in office and conference rooms have been described. The configuration of this test-bed allowed to record a statistically significant set of values of CIR at 27 GHz with a bandwidth of 400 MHz. Three investigated office and conference rooms, including deployment of Tx and Rx antennas inside, have been described. The preliminary analysis of the results consists of the analysis of PDP for selected cases, and statistical analysis of MD and RMS DS for considered rooms. The initial conclusions may be drawn that there is a significant impact of the dimensions of the rooms on the intensity of the multipath phenomenon, which results in lower MD, lower RMS DS and shorter delay interval for the rooms with smaller dimensions. Also, the impact of the aspect ratio of the dimensions and the presence of the slope can not be negligible. That should be considered when applying the model for RMS DS from ITU recommendation [14] where only the surface area of the environment is used. For future work, a detailed statistical analysis of the results will be performed.

6 Acknowledgements

This work was partially funded by the COST Action CA20120, "Intelligence-Enabling Radio Communications for Seamless Inclusive Interactions" (INTERACT) under the Short Term Scientific Mission No. CA20120-2146922e.

References

- [1] A. V. Lopez, et al., "Opportunities and Challenges of mmWave NR," *IEEE Wireless Communications*, **26(2)**, April 2019, pp. 4–6.
- [2] H. Tataria, et al., "Channel correlation diversity in MU-MIMO systems—analysis and measurements," *2019 IEEE 30th Annual International Symposium on*

Personal, Indoor and Mobile Radio Communications (PIMRC), IEEE 2019, pp. 1–7.

- [3] T. Zang, et al., "CSI-RS Based Joint Grouping and Scheduling Scheme with Limited SRS Resources," *2018 IEEE 29th Annual International Symposium on Personal, Indoor and Mobile Radio Communications (PIMRC)*, IEEE 2018, pp. 1–6.
- [4] G. R. MacCartney, T. S. Rappaport, S. Sun, S. Deng, "Indoor office wideband millimeter-wave propagation measurements and channel models at 28 and 73 GHz for ultra-dense 5G wireless networks," *IEEE access*, **3**, 2015, pp. 2388–2424.
- [5] Y. Xing, T. S. Rappaport, A. Ghosh, "Millimeter wave and sub-THz indoor radio propagation channel measurements, models, and comparisons in an office environment," *IEEE Communications Letters*, **25(10)**, 2021, pp. 3151–3155.
- [6] M. Inomata, M. Sasaki, M. Nakamura, Y. Talatori, "Diffuse scattering prediction for 26GHz band in indoor office environments," *IEEE 2017 International Symposium on Antennas and Propagation (ISAP)*, **11**, 2007, pp. 1–2.
- [7] Keysight, "Keysight PNA Network Analyzer N5227B 900 Hz to 67 GHz," 2022, [online] Available: <https://www.keysight.com/us/en/assets/9018-04327/technical-specifications/9018-04327.pdf>.
- [8] RF SPin, "Double Ridged Horn Antenna; Model DRH67," [online] Available: <https://www.rfspin.com/product/drh67/>.
- [9] SAGE, "Ka-Band Omnidirectional Antenna; SAO-2734030345-KF-S1," [online] Available: <https://sftp.eravant.com/content/datasheets/SAO-2734030345-KF-S1.pdf>.
- [10] RFOptic, "40GHz RF over Fiber Mini-Q High SFDR," [online] Available: <https://rfoptic.com/wp-content/uploads/2022/04/RFoF-40GHz-HSFDR-April-2022.pdf>.
- [11] Junkosha, "MWX0 SERIES," [online] Available: <https://www.junkosha-mwx.com/products/download/mwx0.pdf>.
- [12] ITU-R P.341-7, "The Concept of Transmission Loss for Radio Links," Aug. 2019, [online] Available: <https://www.itu.int/rec/R-REC-P.341-7-201908-I/en>.
- [13] <https://www.ni.com/pl-pl/shop/labview.html>.
- [14] ITU-R P.1238-10, "Propagation data and prediction methods for the planning of indoor radiocommunication systems and radio local area networks in the frequency range 300 MHz to 450 GHz," Sep. 2021, [online] Available: <https://www.itu.int/rec/R-REC-P.1238-11-202109-I/en>.