

Fuel systems of high power stationary engine

ARTICLE INFO

Received: 30 May 2023

Revised: 28 June 2023

Accepted: 2 July 2023

Available online: 4 August 2023

The use of alternative fuels and, in the future, synthetic fuels has forced changes in the design of fuel supply systems in internal combustion engines. When operating a stationary engine at constant load, the possibility of using lean fuel mixtures appears. The selection of a precise operating mixture ignition system requires changes in traditional fuel systems. The article presents the current designs of fuel supply systems and their properties. Attention was paid to operating parameters resulting in acceptable emissions of toxic exhaust gas components.

Key words: marine engine, stationary engine, engine fuel system, engine load, exhaust emission limits

This is an open access article under the CC BY license (<http://creativecommons.org/licenses/by/4.0/>)

1. Introduction

Engines used on ships and stationary combustion engines in power plants have very similar fuel supply systems. This is due to the common pedigree of these engines. Manufacturers of high-power engines used them at the beginning as marine ones and later adopted them for land applications. Following the introduction of limits on the emission of other toxic components in marine and land-based engine applications, a distinction should be made between these designs. Because those were the times when the electronic control previously known from the automotive industry was adapted to marine engines, it was enough to diversify the software for main propulsion engines and power generators. However, because of certain differences between the fuel equipment of high-power engines and car engines, it is worth realizing these differences. This article is devoted to presenting the principles of operation of fuel supply systems in high-power engines.

2. Limitations of exhaust gas toxicity

Restrictions on the emission of toxic components in the exhaust gases of stationary engines apply to NO_x, CO, NMHC and particulate matter. Emissions are converted to g/kWh. The exhaust gas purity standards for stationary applications are derived directly from those applicable to marine engines. They take into account the size of the engine, taking into account the displacement and power (Table 1). Engines with a displacement of up to 10 dm³ have relatively high requirements compared to larger engines. Such stationary engines serve as backup power generators and can provide power in the event of a power outage. They often work in urbanized areas. In the US, stationary power plants with multiple high-power generators operating near wind farms or photovoltaics as a backup energy source are also common. Because they are often far from cities, the exhaust gas purity requirements are lower. Requirements introduced for 2007 model year engines. Before this year there were no restrictions and at that time, not the manufacturer but the owner was responsible for the emissions when the technical condition deteriorated.

Table 1. Emission requirements for non-emergency stationary engines [3]

Displacement	Power	Year	Emission certification
< 10 dm ³ /cyl	<= 3000 hp	2007–	Tier 2/3/4
		> 3000 hp	Tier I
	2010–	Tier II/IV	
10–30 dm ³ /cyl.	all	2007–	Marine Cat. 2 Tier III/IV
> 30 dm ³ /cyl.	all	2010–2011	Marine Cat. 3 Tier I
		2012–	Marine Cat. 3 Tier II/III

In marine applications, limits for the emission of toxic exhaust components apply only to engines with a power of more than 130 kW. Regulation 13 of MARPOL Annex VI then applies. Offshore watercraft engines and emergency engines are not subject to this convention.

The limits of the permissible emission of toxins in exhaust gases depend on the sailing area of the vessel. Tier I and Tier II are applicable in all international seas, while Tier III is only in Emission Control Areas. The main parameter on which the permissible value depends is the engine speed.

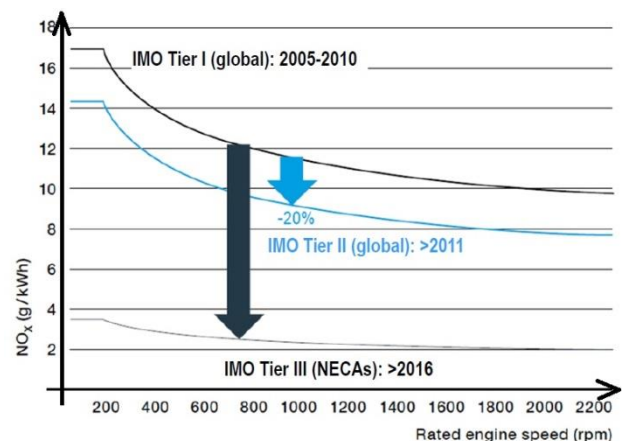

Fig. 1. Allowable NO_x emissions in exhaust gases [3]

3. Stationary and marine engine loads

Unlike engines used in vehicles and working machines, the rotational speed and often the load remain constant over long periods of operation of stationary and marine engines. The stability of parameters facilitates the design and testing of motors.

The studies presented in [1] indicate significant differences between the operating conditions and the valid tests that are used to measure engine emissions. These differences are shown in the graphs in Fig. 2 and 3. Load distributions differ a lot between electricity production – auxiliary engines and main engine.

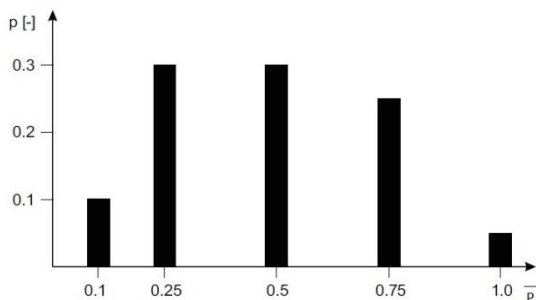

Fig. 2. Load distribution of a ship power plant [1]

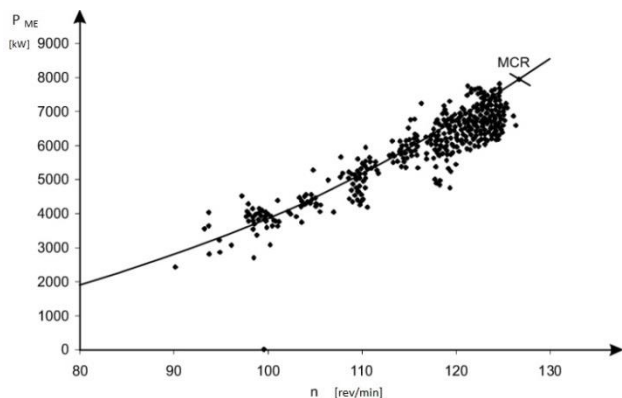

Fig. 3. Ship main engine load and speed distribution [1]

Currently, more and more hybrid propulsion systems are used, especially on specialized vessels (Fig. 1). If the electrical energy storage is capacious or the unit is often maneuvering, there is a chance for long-term operation of the engine with a full load and then idling. This way of operation indicates the need to change the tests to those shown in Fig. 4.

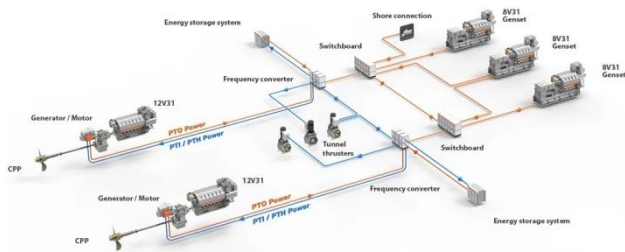

Fig. 4. Modern roto/ferry ship propulsion system [2]

The hybrid propulsion system has the advantage that it can accumulate electric energy when braking the ship, but it is only useful during maneuvers in ports.

4. Design solutions for liquid fuel supply systems for two-stroke engines

After many years of production of traditional fuel systems, in 2001 the slow-speed two-stroke engine of the RT flex family appeared and the era of high-power electronically controlled engines began [11]. For the first time, electronic control of the operation of fuel injection systems, opening the exhaust valve and starting the engine with compressed air was used (Fig. 5). The fuel system used the idea adopted earlier in the automotive industry to supply fuel to the cylinder under constant pressure from a pressure accumulator.

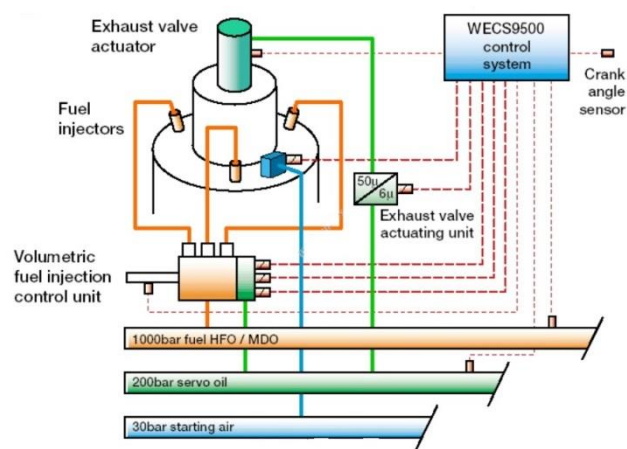

Fig. 5. Wärtsilä RT flex fuel supply system [6]

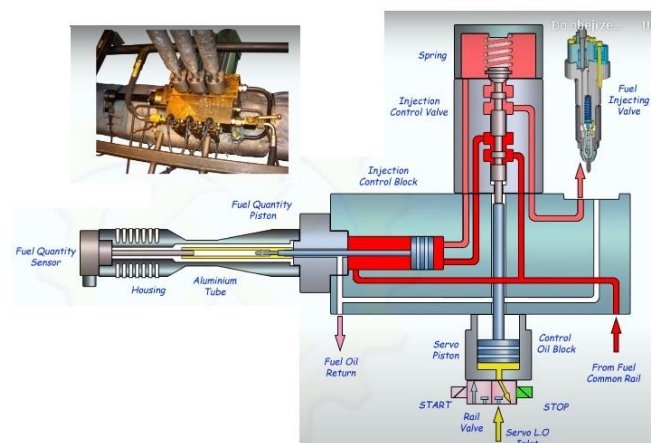

Fig. 6. Wärtsilä RT flex fuel supply [8]

However, due to the lower rotational speed and thus longer injection time, such high pressures and short injection times are not used in many phases. More important is mechanical-hydraulic rate limiting and reliability. With large cylinder diameters, 3 injectors are used.

The operation of this system is based on the fuel under pressure (100 MPa) accumulated in the tank and the use of control oil under the pressure of 20 MPa in the tank (Fig. 6).

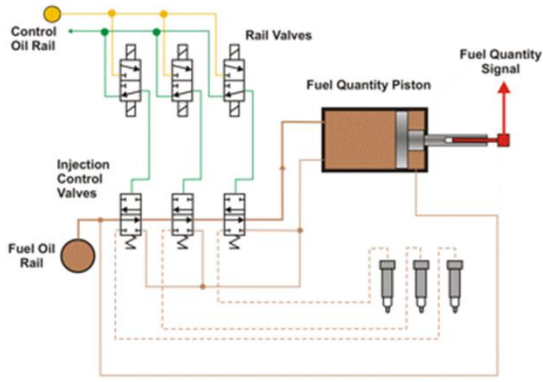

Fig. 7. Control in the RT flex fuel supply system [6]

At the beginning of the process, when the control oil does not flow into the oil cylinder, the fuel supply valve to the dose metering chamber is opened and the valve to the injectors is closed. After overriding the hydraulic distributor, the oil cylinder closes the dose metering valve and opens the filling injector. When the hydraulic distributor returns to the stop position, injection ends. Due to the 3 injectors in each cylinder, the control system for the cylinder includes 3 hydraulic distributors and one fuel tank (Fig. 7).

The described control enables full monitoring of its parameters. The screens of the monitoring program present operating parameters such as the volume of injected fuel, fuel pressure, injection times, and delay times between the signal and the actual injection start. Selected of these parameters are shown in Fig. 8.

The amount of injected fuel is measured by a fuel quantity sensor in the injection control unit (ICU).

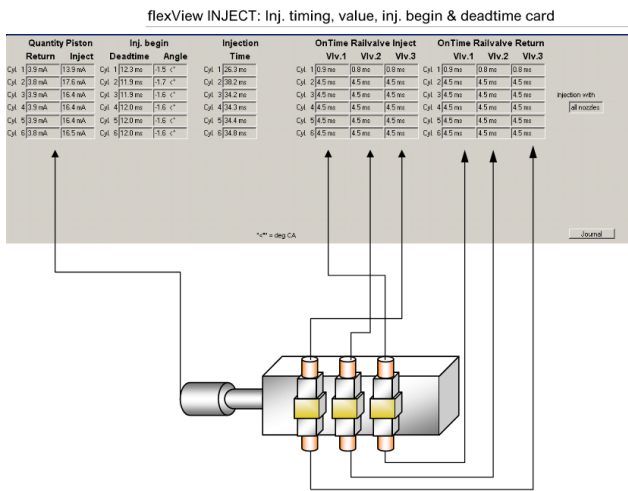

Fig. 8. Control screen of operating parameters of the RT flex power supply system [9]

In MAN engines, the design solution is also based on the use of a spool valve operated by control oil under an overpressure of 20 MPa. The difference from the previously described Wärtsilä design is the use of a hydraulic booster to create high fuel pressure. The differential piston, actuated by the control oil, expels the fuel under high pressure (Fig. 9).

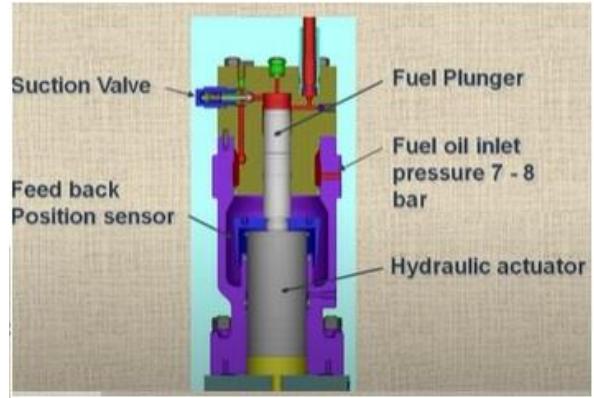

Fig. 9. Hydraulic amplifier in the fuel supply system – MAN [7]

5. Design solutions for liquid fuel supply systems for four-stroke engines

Electronic control has also been used in four-stroke engines since 2001. Due to their higher rotational speeds, the control processes must be faster. For faster fuel evaporation, a higher fuel pressure is used during injection, e.g. 160 MPa. The design of the system for MAN is somewhat similar to systems for car engines. The hydraulic diagram of the MAN heavy fuel supply system is shown in Fig. 10.

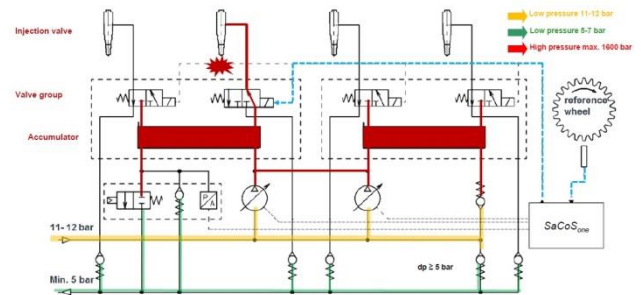

Fig. 10. Hydraulic scheme of heavy fuel supply in four-stroke MAN engines [7]

It uses three levels of fuel pressure. Power supply for high-pressure pumps is 1.2 MPa, injection pressure is 100–160 MPa and overflow pressure is 0.5 MPa. Contrary to the well-known construction of electromagnetic CR injectors in passenger car engines, the described MAN solution uses a valve with a control chamber closed with a ball (as in cars), but located at the fuel accumulator and connected to the mechanical injector by a high-pressure pipe (Fig. 11).

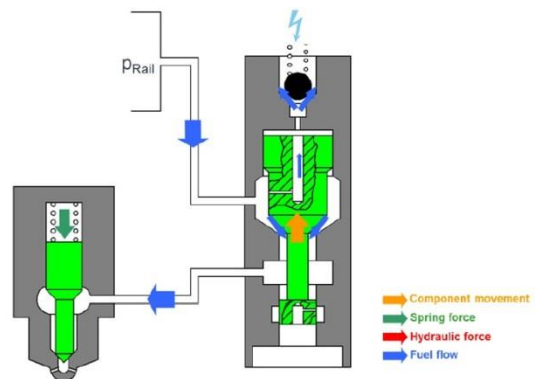

Fig. 11. Valve and injector [7]

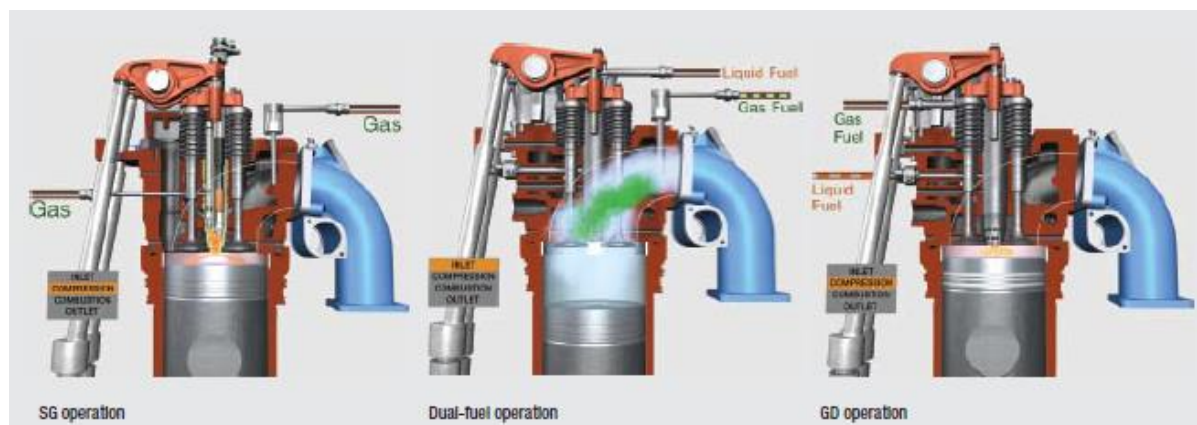

Fig. 12. Tree systems of 4 stroke engine operations: SI, dual fuel, diesel [11]

When using heavy fuel, it is necessary to flush the system with light fuel for 2 minutes before stopping the engine.

6. Gas fuel supply systems

The desire to use gaseous fuels as an alternative to liquid fuels resulted in the development of dual-fuel (diesel cycle) or spark-ignition gas engines of high power. Dual-fuel engines are used in marine and stationary propulsion systems, while gas-fired engines are used only as stationary ones. The diesel engine requires a pilot dose of diesel fuel to initiate the combustion process. The main fuel is vaporized or expanded natural gas or LPG. The cross-section of the cylinder head and combustion chamber of such an engine is presented in Fig. 12.

In four-stroke engines, direct injection into the combustion chamber is used for the pilot dose and the introduction of the main gas dose before the intake valve. As a dual fuel engine is designed for continuous operation in gas operating mode or diesel operating mode. The gas fuel (for full load operation) must have at least $LHV = 25 \text{ MJ/kg}$, methane number 70 [2]. Gas is stored in marine applications as liquid (LNG or LPG).

The Wärtsilä company introduced dual fuel engines also in the low-speed engine version.

Powerful four-stroke dual-fuel engines have been developed for many years. Recently, the technique of co-salting oil and methane for two-stroke engines has been introduced. The technical solution is significantly different. Gas is introduced into the cylinder in the middle of the piston stroke through holes in the cylinder liner. Gas is the main fuel as it accounts for 99% of the energy supplied at maximum engine load. The mixture in the cylinder is lean. For effective ignition, there are 3 pre-chambers in the head and oil is injected into them. (Fig. 13).

7. Development trends of fuel supply systems

Recent literature mentions the design of other fuels in dual fuel systems. Their task is to replace some of the carbon-containing fuels with hydrogen carriers. Ammonia may be such a carrier. In the article [12] the co-combustion of ammonia and methane in a high-pressure medium-speed four-stroke natural gas engine was modeled. As it is already implemented in SI gas engines, the authors propose a pre-chamber for ignition initiation. The use of a pre-chamber

proved necessary when the research on flame formation and the formation of toxic exhaust compounds was carried out. Ammonia pyrolysis promotes the formation of a flame. This flame then travels from the induction chamber to the main chamber. Then, strong charge vortices are created in the main chamber and the flame can spread despite the lean mixture zones in the main chamber. The trends in nitrogen oxide emissions were not clear because when NO decreased, N_2O increased. Ammonia turned out to be a catalyst for NO decomposition.

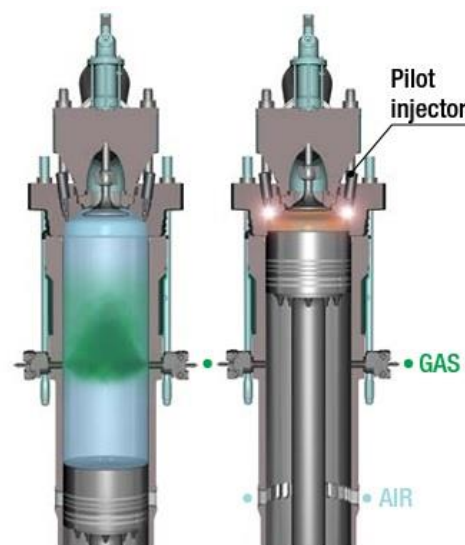

The 2-stroke DF principle with gas admission (left) and ignition (right).

Fig. 13. Dual fuel two stroke engine [10]

In multi-cylinder engines, uneven loading of individual cylinders results in many unfavorable phenomena, such as crankshaft vibrations, pressure fluctuations in the intake and exhaust systems, and deterioration of cylinder flushing. Exhaust gas temperature sensors were introduced to prevent uneven loading of the cylinders. In the past, such sensors were used by the crew to monitor engine operation. Currently, they operate automatically in the feedback loop, controlling the size of the injected dose and the division into injection phases.

Diagnosis methods based on rotational speed measurement are also being developed [4]. In this article, the authors developed the theory of diagnosing the combustion process based on the course of the instantaneous rotational speed. The possibility of mounting a precise shaft speed transducer in a large motor improves the quality of the data obtained. They called their prototype measurement and analysis system SpeedMA.

8. Mathematical modeling of processes in high power engines

Currently, methods of mathematical modeling of processes are being developed to improve environmental and operational parameters. They are based on the black box approach of elemental neural networks [5, 14].

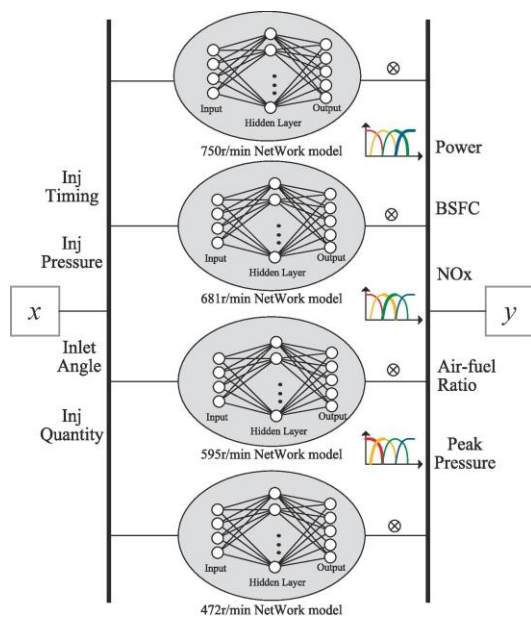

Fig. 14. The structure of the data-driven model [14]

The methods of assessing changes in the crankshaft speed were and are used in car engines in on-board diagnostic systems of the OBD type at the end of the 1990s. Simple algorithms were used to calculate the acceleration of the crankshaft in the expansion strokes of individual cylinders. Engine running erratically is a warning sign of large increases in exhaust emissions, especially hydrocarbon emissions. The authors of the publication [5] significantly developed the theory in order not only to diagnose but also to improve fuel dosing control. They used fuzzy logic to build a mathematical model describing many different processes in the engine. This complicated model is shown in Fig. 14.

Conclusion

High-power engines are fundamentally different in the construction of fuel systems from those used in the automotive industry. The main reason for the differences is different fuels and long-term operation at constant load. I notice a tendency to use gaseous fuels instead of liquid fuels. Control systems that make the operation of the fuel system dependent on the properties of fuels are being developed. Recent literature mentions the design of other fuels in dual fuel systems. Their task is to replace some of the carbon-containing fuels with hydrogen carriers. Ammonia may be such a carrier. The co-combustion of ammonia and methane in a medium-speed four-stroke natural gas marine engine is considered. As it is already implemented in SI gas engines. The pre-chamber is proposed for ignition initiation. The development of fuel systems is influenced by three main factors use of new fuels, new emission regulations, and changes in load distribution.

Efforts are being made to introduce models of engine operation using machine learning for their control under changing operating conditions.

Due to the use of fuels with inferior properties, control algorithms appropriate for the current fuel are introduced.

Nomenclature

CI compression ignition
LNG liquefied natural gas
OBD on-board diagnostic

LPG liquefied petroleum gas
SI spark ignition

Bibliography

- [1] Balcerski A, Kropiwnicki J. Remarks upon adequacy of conditions of ISO 8178 emission tests with regards to real operation conditions of marine engines. *Journal of KONES*. 2008;23-30.
- [2] Electric shipping and hybrid ships. <https://www.wartsila.com/marine/products/ship-electrification-solutions>
- [3] IMO Marine Engine Regulations <https://dieselnet.com/standards/inter/imo.php>
- [4] Kazienko D, Chybowski L. Instantaneous rotational speed algorithm for locating malfunctions in marine diesel engines. *Energies*. 2020;13:1396. <https://doi.org/10.3390/en13061396>
- [5] Kowalski J. The model of combustion process in the marine 4-stroke engine for exhaust gas composition assessment. *Combustion Engines*. 2016;165(2):60-69. <https://doi.org/10.19206/CE-2016-208>
- [6] Mańczak J. Silnik okrętowy RT-flex 60C/RT-flex 60C Marine Diesel Engine. *Silniki Spalinowe*. 2004;118(1):10-18.
- [7] MAN Energy Solutions. www.man-es.com
- [8] RT Flex Fuel Operation. www.youtube.com/watch?v=dOEMn7LhbaA
- [9] Wartsila: Manual Operator flexView. FlexView configuration revision 3496 with lexView.exe version 3.9.7.
- [10] Wartsila: Wartsila low-speed dual-fuel solution.
- [11] Woodyard D. *Pounder's Marine Diesel Engines and Gas Turbines*. 8th Edition, 2003 eBook.

- [12] Wu X, Feng Y, Gao Y, Xia C, Zhu Y, Shreka M et al. Numerical simulation of lean premixed combustion characteristics and emissions of natural gas-ammonia dual-fuel marine engine with the pre-chamber ignition system. *Fuel*. 2023; 343:127990. <https://doi.org/10.1016/j.fuel.2023.127990>
- [13] Xie L, Sun S, Dong F. The non-uniformity control strategy of a marine high-speed diesel engine based on each cylinder's exhaust temperature. *Processes*. 2023;11(4):1068. <https://doi.org/10.3390/pr11041068>
- [14] Zhang J, Meng Y, Liu D, Liu L, Ma X, Jiang C et al. Modeling and multi-objective combustion optimization of marine engine with speed maintaining control target. *Thermal Science and Engineering Progress*. 2023;41:101852. <https://doi.org/10.1016/j.tsep.2023.101852>

Zbigniew Kneba, DSc., DEng. – Faculty of Mechanical Engineering and Ship Technology, Gdansk University of Technology.
e-mail: zkneba@pg.edu.pl

