

## RESEARCH ARTICLE

# Comparison of Doppler Effect Estimation Methods for MFSK Transmission in Multipath Hydroacoustic Channel

AGNIESZKA CZAPIEWSKA<sup>1</sup>, ANDRZEJ ŁUKSZA<sup>2</sup>, RYSZARD STUDAŃSKI<sup>2</sup>,  
ŁUKASZ WOJEWÓDKA<sup>2</sup>, AND ANDRZEJ ŻAK<sup>3</sup>

<sup>1</sup>Faculty of Electronics, Telecommunications and Informatics, Gdańsk University of Technology, 80-233 Gdansk, Poland

<sup>2</sup>Faculty of Electrical Engineering, Gdynia Maritime University, 81-255 Gdynia, Poland

<sup>3</sup>Faculty of Mechanical and Electrical Engineering, Polish Naval Academy, 81-127 Gdynia, Poland

Corresponding author: Łukasz Wojewódka (l.wojewodka@we.umg.edu.pl)

This work was supported by the National Centre for Research and Development under Project DOB-SZAFIR/01/B/017/04/2021.

**ABSTRACT** Underwater wireless communication remains a challenging topic, particularly for applications such as wreck penetration where multipath and Doppler effects are very intense. These effects are becoming even more difficult to mitigate for fast data transmission systems that utilize wideband signals. Due to the low propagation speed of acoustic wave in the water, there is a significant difference between the Doppler shift for lower and upper frequencies of the utilized spectrum. To address these challenges, this paper describes various methods for determining the Doppler frequency shift for MFSK signals, including cross-correlation, double FFT, pilots, and additional Up-Down chirp signals. The reception quality of the transmitted data in a real environment was used as an evaluation criterion for each method. The tests were carried out in motion within the towing tank for different movement speeds of the transmitter relative to the receiver. The tank's limited dimensions created conditions for multipath signal propagation. Under very difficult multipath signal propagation conditions, the pilots method was found to be the most effective. It gave over two times lower BER than the well-known Up-Down chirp method.

**INDEX TERMS** Underwater communication, multipath channels, Doppler shift, Doppler measurement.

## I. INTRODUCTION

With the continuous development of underwater technology, the need to provide wireless underwater communication is becoming more necessary. Despite the long history of research in the field of wireless underwater communication, the number of viable solutions remains limited. The most common communication medium is elastic wave. Propagation conditions depend on the body of water, including the presence of underwater obstacles, the type of bottom, the depth of the body of water, meteorological conditions, water stratification, physicochemical properties, etc. This leads to a wide variety of propagation conditions which make it difficult to implement a universal communication underwater system. Moreover, the relative motion between the receiver

and the transmitter also has a significant effect on reception quality due to the low (1500 m/s) propagation speed. The overall effect is that multipath and Doppler phenomena become particularly important in difficult propagation conditions. Examples include communication between a base ship and a submersible operating in a harbor basin, or communication between a submersible and a diver performing underwater work inside a wreck. Multipath conditions result from multiple reflections of the generated acoustic wave from various underwater obstacles, walls of oceanographic structures, etc. The Doppler phenomenon is caused primarily by the movement of the receiver relative to the transmitter. The simultaneous occurrence of these two phenomena leads to a situation in which the receiver repeatedly registers a transmitted signal arriving via different paths with a different value of Doppler frequency shift in each path [1], [2]. This causes, not only a frequency shift of the transmitted

The associate editor coordinating the review of this manuscript and approving it for publication was Tao Wang<sup>1</sup>.

signal, but also its blurring in the frequency domain. Overall, it leads to a situation where underwater communication is significantly hampered or even impossible. In such cases, special modulation techniques and additional procedures are required to reduce the impact of both phenomena.

An example of modulation relatively resistant to the influence of multipath effect is Multiple Frequency Shift Keying (MFSK) [3], which results from the fact that the decision-making process is based on the amplitude spectrum of the signal, so it does not matter which paths it takes to reach the receiver. Unfortunately, this modulation is not immune to the Doppler phenomenon, which causes a shift in the frequency domain of the carriers on which data are transmitted. In addition, multipath propagation causes a blurring of the spectrum of these carriers which makes it difficult to identify them correctly. To ensure reception, additional processing must be applied, for which knowledge of the carrier position correction factor in the frequency domain is essential. This factor can be determined by various methods. The aim of this paper was to evaluate different methods for determining the Doppler factor under strong multipath conditions. The study was carried out for MFSK modulation described in [4] and the evaluation of the methods was based on the bit error rate.

In general, topics related to the Doppler phenomenon in wireless underwater communication using acoustic wave are widely discussed in scientific publications. This is due to the fact that when a link has to be established for moving objects, it is required to take into account the signal offset in the frequency domain at the receiver. Without this, at certain speeds, it is practically impossible to receive the transmitted data. The knowledge of the Doppler is also required in underwater navigation and localization systems [5] as well as in motion parameter estimation of autonomous underwater vehicles [6]. In the vast majority of cases, chirp signals [7], especially linear [8], [9], [10] or hyperbolic [11], [12], are used to determine the Doppler shift. In such cases, the difference in time of occurrence of two chirp signals transmitted with a certain time interval is determined and from this the Doppler factor is calculated, allowing the received signal to be corrected [13]. The correction usually consists of resampling the received signal [1], [14] although there are other approaches, such as [15], where the use of RLS filtering and PLL loops has been proposed. The paper [16] uses Kalman filtering for Doppler estimation and correction. On the other hand, in paper [13], based on test data, a correction of the Doppler phenomenon is selected so that the minimum value of the bit error rate is obtained. The authors of [18] propose a two-step approach to Doppler mitigation, namely non-uniform Doppler compensation by resampling, which transforms the broadband problem into a narrowband problem, followed by high-resolution uniform compensation of the remaining Doppler effect. In [19], [20], and [21], it was proposed to use multi-channel correlation integrated with different Doppler shifts to estimate approximate Doppler shifts. Similarly, in [22] a method for estimating the Doppler

phenomenon based on the analysis of transmitted two identical OFDM symbols together with a cyclic prefix, while the receiver uses a bank of parallel autocorrelators, each matched to a different Doppler scaling factor, was proposed. In [23] the authors propose and investigate a multibranch autocorrelation (MBA) Doppler estimation method, which can be used in communication systems with periodically transmitted pilot signals or repetitive data transmission. Another very popular solution is the use of pilots as a mean of estimating the Doppler effect [9], [24]. There are also propositions to use only direct paths during signal receptions which is possible in DSSS techniques [25].

However, it should be noted that most of the publications deal with hydroacoustic signal propagation in conditions where multipath effect does not occur or is negligible [8], [16], [17], [18], [19], [21], [24]. Some research has been carried out under simulation conditions [13], [26], [27], [28]. In this case, there are made assumptions that greatly simplify the models used, but at the same time result in significant deviations from conditions encountered in reality. There has also been some research conducted under real conditions [8], [18], [21], [24].

Despite the abundance of available literature, the authors of this paper have not encountered publications in which studies related to the Doppler effect under multipath propagation conditions are presented, as occurs in the following research. As the goal of our work is to develop an underwater wideband communication system for moving objects which will work in shallow water where the multipath effect is significant, the implementation of a method for Doppler factor determination is crucial. Therefore, in this paper we present comparison of four selected methods with utilization of real signals recorded in real multipath environment. Four methods were investigated: Up-down chirp, pilots method, double FFT, and correlation method. The last two are novel methods first time proposed in this paper.

The main contribution of this paper is the introduction of two new methods dedicated for MFSK modulation which enable the determination of the Doppler factor, namely the double FFT and the correlation method. The main advantage of those methods is the usage of data transmitted in the MFSK signal without the need for additional signals or data that will lower the throughput. Another important contribution is the assessment of those methods with utilization of signals transmitted in the real, multipath environment. The measurement campaign was conducted in such a way that enabled comparison of the proposed methods with the well-known up-down chirp method and one which utilizes pilot signals as well.

In order to verify the proposed solutions, a series of measurements were carried out in motion, in the towing tank, using transmission based on MFSK modulation. The results obtained make it possible to identify the potentially best, in terms of bit error rate, methods for determining the correction factor that reduces the influence of the Doppler effect on the received signal.

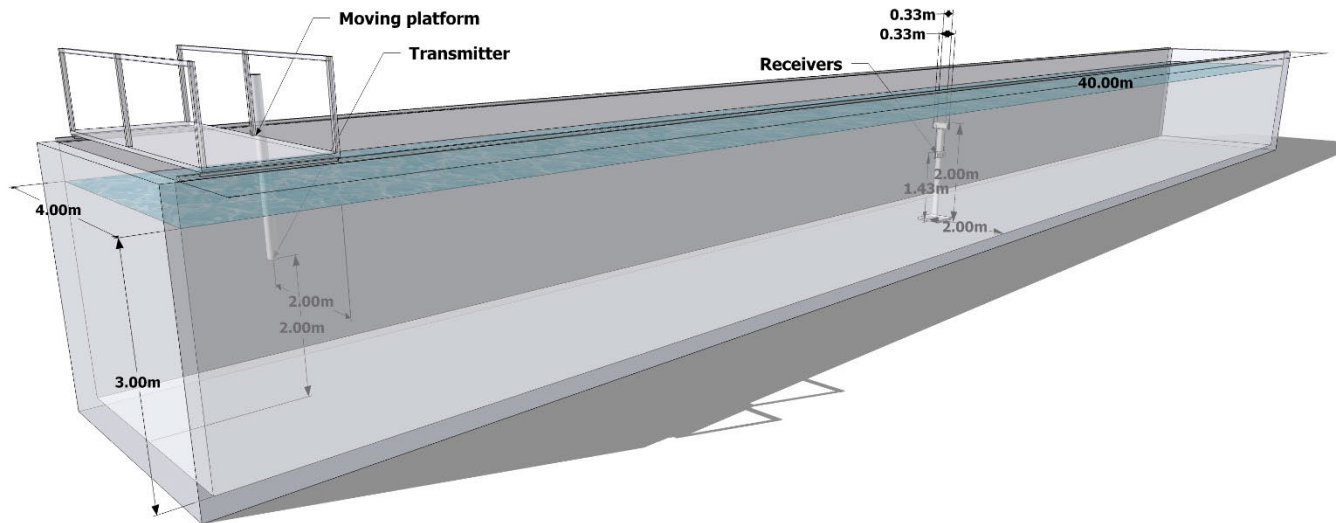

FIGURE 1. Deployment of the measuring devices in the towing tank.

The rest of the article is organized as follows: Section II of the article presents a description of the measurement station and the method of signal formulation. The next section discusses in detail the methods of estimating the Doppler coefficient, i.e., based on pilots, chirp signals, using double FFT, and correlation. This is followed by a presentation of the results of the tests carried out under strong multipath and reciprocal motion of the transmitter and receiver. There is also an analysis of the complexity of all considered methods. Finally, the conclusions drawn from the analysis of the obtained results are indicated.

## II. MEASUREMENT METHOD

### A. MEASUREMENT STAND

Measurements were conducted in the freshwater towing tank of the Faculty of Mechanical Engineering and Ship Technology at the Gdansk University of Technology, presented in Fig. 1. The water column was 3 m deep, 4 m wide and 40 m long. Near the end of the towing tank (before the mechanical break for the moving platform), in line with the transmitter's movement, four receiving transducers (Rx) were placed on a mast standing at the bottom of the tank (Fig. 2). Lower transducers were 1.43 m above the bottom, upper ones were 2 m above the bottom. The distance between Rx transducers on the same level was 0.33 m. The lower transducers were rotated 90 degrees relative to the upper ones. The mast with Rx transducers was placed 1.8 m from the right edge of the tank. The transmitting transducer (Tx) was submerged at the depth of 1 m and 2 m from the right edge of the tank and placed on a moving platform. The speed of the platform could be adjusted within the range from 0 up to 2 m/s with 0.01 m/s precision. The Tx transducer was hidden inside the mast to protect it from the water flow. The mounting was stiffened with steel lashings as shown in Fig. 3. Thanks to this construction, the Tx transducer did not vibrate during movement. The



FIGURE 2. Receiving transducers on a mast at the bottom of the towing tank.

distance between the position of Rx transducers in the tank and the point where the movement of the platform became uniformly rectilinear was 19.2 m. The tank in which the tests were performed is characterized by a strong multipath effect, which was proven in our previous publication [29]. Moving the transmitter relative to the receivers causes a Doppler effect.

In the transmitting part of the measurement stand, the signal was digitally formed in a Matlab environment and sent via an NI USB-6366 DAC to an ETEC PA1001 amplifier and further to a Reson TC4013 transducer. The receiving part consisted of four Reson TC4013 transducers, 5 channel Etec A1105A transducer amplifier (during preliminary trials a Reson EC6081 preamplifier was also used) and a NI



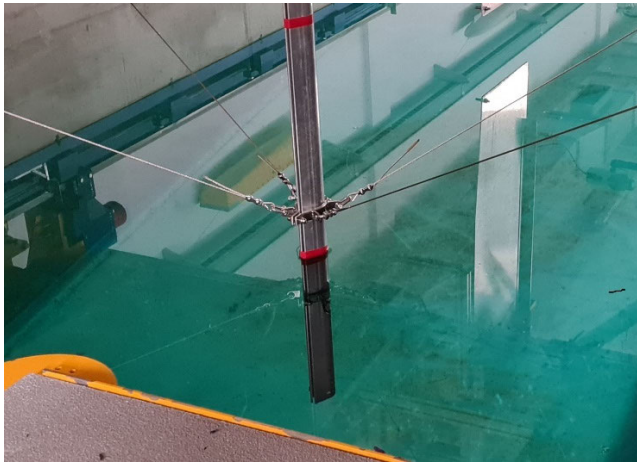

FIGURE 3. Transmitting transducer hidden in the mast and stiffened with steel lashings.

USB-6366 ADC converter. Signal samples from all 4 channels were recorded for post-processing. The advantage of this solution, apart from ergodicity, was ensuring the same time base for the sampled signals in all receiving channels.

The sound speed in the towing tank was measured using a Valeport SWIFT CTD Plus probe. At a depth of 1.15 m the sound speed was 1476.4 m/s, at a depth of 1.6 m it was 1476 m/s, at a depth of 2.65 m it was 1475.4 m/s. For reception, the propagation speed was set to 1476 m/s.

**B. SIGNAL FORMULATION**

For the data transmission an MFSK (Multiple Frequency Shift Keying) modulation was used, which was already described in [4]. In this modulation one bit is transmitted with the utilization of two carriers. This modulation was chosen because it has been proven to be resilient to multipath effect in our previous research. This is modified type of MFSK modulation according to the presented in [3]. The frequency distance between the carriers in the presented measurement results was 160 Hz. The spectrum occupied by the MFSK signal ranged from 65 kHz to 145 kHz. Simultaneously with the MFSK signal, chirp signals were transmitted on frequencies 58 kHz and 152 kHz with a bandwidth of 10 kHz. On each mentioned frequency, two chirp signals were transmitted: Up and Down [30]. Fig. 4 presents a spectrum of one package of signals consisting of MFSK (red rectangle) and chirp (green rectangle) signals. Chirp signals are needed mainly for symbol synchronization and impulse response estimation. However, there is also a possibility to extract the Doppler shift from those signals. The time duration of MFSK signal was equal to 50 ms and the chirp signal duration was 30 ms. The structure of the signal over time and frequency is presented in Fig 5. After each signal package there was a 100 ms time of silence (a kind of guard interval) as the channel memory was very long. Fig. 6 presents the first two signal packages of the recorded signal in the time domain. The dashed line indicates the approximated signal level after the guard interval. It can

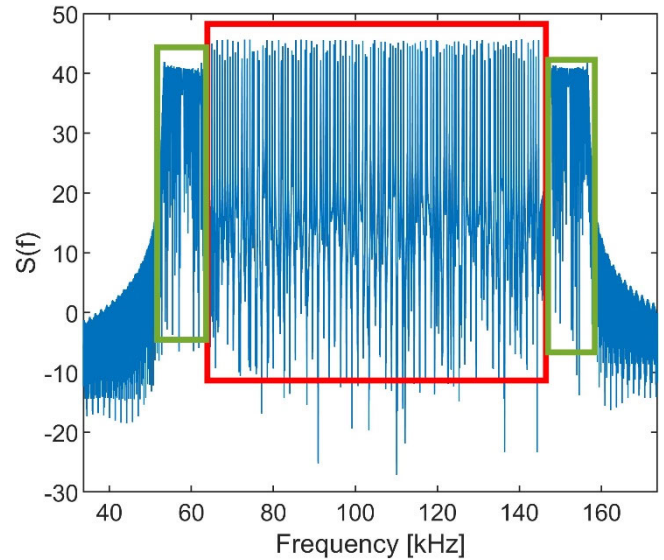

FIGURE 4. Spectrum of one transmitted signal package.

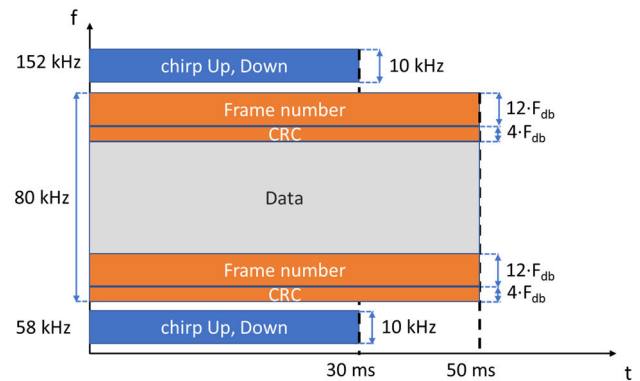

FIGURE 5. Signal structure along time and frequency.

be seen that the channel has not been entirely muted despite the long guard interval.

In each MFSK symbol, a frame number and randomly selected data were transmitted. The transmitted signals and selected data for every symbol were stored for Bit Error Rate (BER) calculations in the receiver. During the measurements, three platform speeds were chosen: 0.5 m/s, 1 m/s, and 1.5 m/s. For each speed, a couple of measurements were performed to achieve a better quality of BER estimation. Later in the text a single moving platform pass will be called a “test”. As the Doppler frequency shift is different for different carrier frequencies, the Doppler factor parameter  $\mu$  was used defined as:

$$\mu = \frac{c + v_r}{c + v_s}, \tag{1}$$

where  $c$  is the speed of the acoustic wave in water and  $v_r$  is the velocity of the receiver (positive if the receiver is moving towards the source), and  $v_s$  is the velocity of the source (positive if the source is moving away from the receiver). In the towing tank, the  $\mu$  values for selected speeds were

MOST WIEDZY Downloaded from mostwiedzy.pl

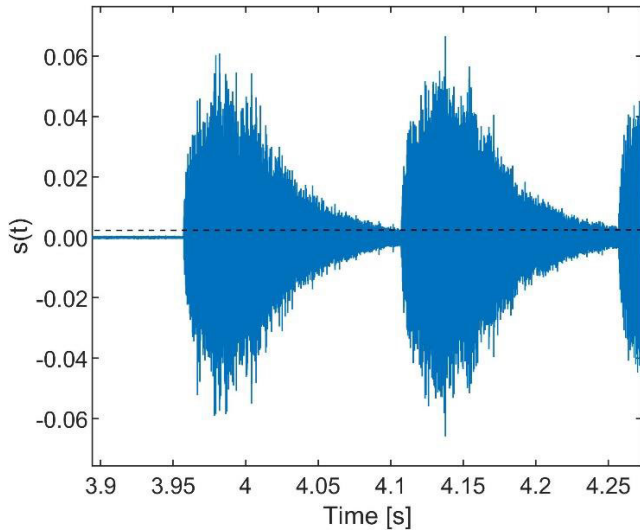

FIGURE 6. Two first received signal packages.

TABLE 1. Calculated values of the Doppler factor.

Speed of the transmitter	Calculated value of the Doppler factor
0.5 m/s	1.00034
1 m/s	1.00068
1.5 m/s	1.00102

presented in Table 1. However, after the initial attempts to receive recorded signals, it became apparent that these values were not optimal. Hence, for each symbol, an appropriate  $\mu$  value was determined to enable reception with the lowest possible error. This will later be referred to as an optimal  $\mu$  in the text. However, ranges of  $\mu$  value were found, which gave the same lowest BER values due to the good quality of the received signal. Therefore, in the article the optimal  $\mu$  and BER achieved for this  $\mu$  are presented in Fig. 10, 12, and 14 as a heat map, where the mentioned ranges of the same BER can be seen.

For a wireless communication link, achieving the lowest possible BER simultaneously with the highest possible throughput is crucial. Therefore, in the following paper, for every considered Doppler factor estimation, the BER was calculated and compared to the achieved one for the optimal  $\mu$ .

### III. DOPPLER FACTOR ESTIMATION METHODS

In the receiver, the frequency of the coming signal must be known. However, due to the Doppler effect, it is usually different from the frequency of the transmitted signal. In a hydroacoustic channel, because of low propagation speed (1476 m/s), the frequency shift might be significant. If the receiver is approaching the transmitter emitting a signal on 145 kHz with a speed of 1.5 m/s, the change in frequency will be 147 Hz. In the following paper, four different approaches to estimate the Doppler factor are compared. The first one utilizes chirp signals, the other three use the properties of

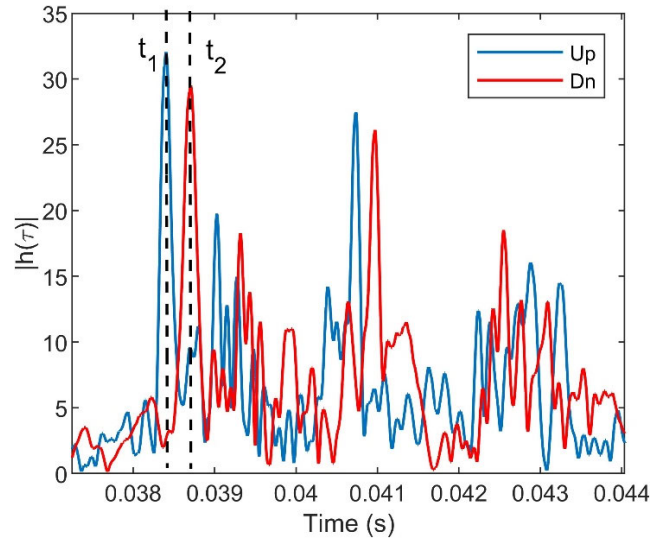

FIGURE 7. Estimated impulse response for chirp Up and Down signals recorded when the carriage moved with 0.5 m/s speed.

MFSK signal. All of them are described in the following subsections.

#### A. UP-DOWN CHIRP

Chirp signals are often used for impulse response estimation because a chirp filtered by the matching filter produces a single peak. If a chirp is transmitted through a channel with multipath effects, the filtering operation gives the estimation of the impulse response of the channel. Fig. 7 presents the estimations of impulse responses achieved with the utilization of chirp signals, Up and Down, which were transmitted at the same time. It is evident that those signals reached the receiver at different times. This difference is the information that may be utilized to calculate the Doppler factor. From [31], [32], and [33] we know that Doppler frequency shift is

$$f_d = \frac{\Delta t \cdot B}{2 \cdot T}, \tag{2}$$

where, according to Fig. 7,  $\Delta t = t_2 - t_1$ ,  $B$  is the chirp bandwidth, and  $T$  is the time of chirp duration. It is also known that Doppler factor can be calculated as

$$\mu = \frac{F_C + f_d}{F_C}, \tag{3}$$

where  $F_C$  is the carrier frequency. Therefore, utilizing the  $\Delta t$  Doppler factor can be calculated as

$$\mu = 1 + \frac{\Delta t B}{2 \cdot F_C \cdot T}. \tag{4}$$

Usually, it is not a trivial task to decide which peaks from the estimated impulse responses should be compared. Therefore, in the presented method, those local maxima are not searched, but the cross-correlation of the estimated impulse response is calculated. Then, the alignment of the correlation maximum informs if the transmitter and receiver are moving away or approaching each other. If the maximum is in the first

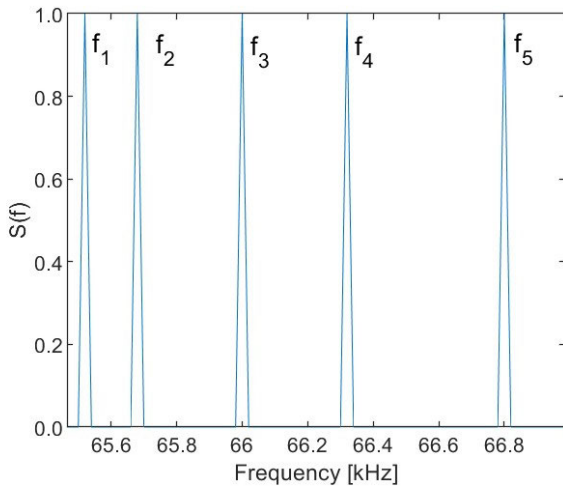

FIGURE 8. Part of the MFSK spectrum.

part of the cross-correlation function, it means approaching. If it is in the second part, it means moving apart. Then the number of samples from the beginning (approaching) or end (moving apart) determines the value of  $\Delta t$ .

### B. DOUBLE FOURIER TRANSFORM ON MFSK

The Fourier transform is a very good tool to recover some periodicity from the signal, which is seen in the spectrum as a peak on particular frequency corresponding to the period. The spectrum of an MFSK signal can be considered periodic, if the distance (in frequency) between each spectrum peak is equal to  $F_{db}$ ,  $2 \cdot F_{db}$ , or  $3 \cdot F_{db}$ , where  $F_{db}$  is the frequency separation between carriers in one bit (one bit is built by two carriers – the value of the bit determines which carrier will transmit the power). Fig. 8 presents a part of an MFSK amplitude spectrum with an explanation of the  $F_{db}$  parameter, where:  $f_1$  is equal to 65520 Hz,  $f_2 = 65680$  Hz,  $f_3 = 66000$  Hz,  $f_4 = 66320$  Hz and,  $f_5 = 66800$  Hz. The  $F_{db}$  was set to 160 Hz. It is observed that the difference between the second and the first marked frequencies is  $F_{db}$ , third and second is  $2 \cdot F_{db}$ , and fifth and fourth is  $3 \cdot F_{db}$ .

If another Fourier transform were performed on the amplitude MFSK spectrum, then in the new spectrum there would be peaks corresponding to  $F_{db}$  and its harmonics, which are shown in Fig. 9. The number of those spectrum components may be calculated as follows:

$$K_N = \frac{N \cdot F_s}{F_{db}}, \quad (5)$$

where  $N$  is the harmonic number and  $F_s$  is the sampling frequency. The sampling frequency for the presented signals was set to 500 kHz. Therefore,  $K_1 = 3125$ . In Fig. 9, the index is equal to 3126, as Matlab starts indexing from 1.

If, during transmission, the Doppler effect occurs, then the  $F_{db}$  parameter will be changed by the Doppler factor  $\mu$ . Therefore, the value of indexes  $K_N$  of peaks in the double Fourier transform of the received MFSK signal will change according to  $\mu$ . So, observation of the value of  $K_N$  of the received signal should allow estimation of the Doppler factor.

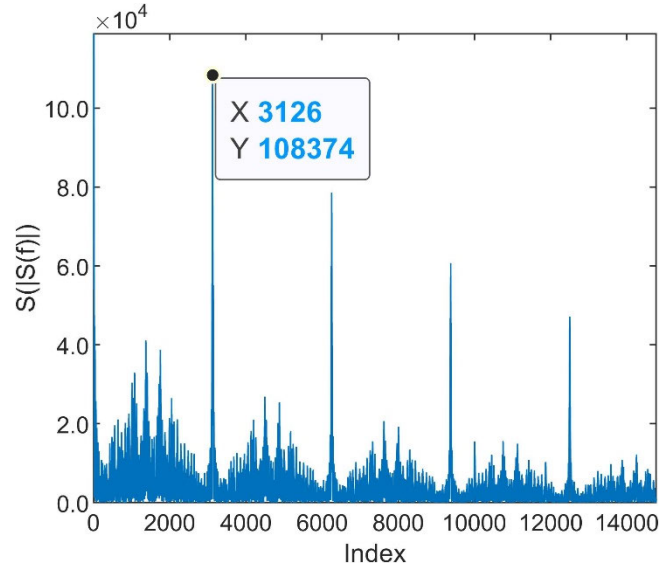

FIGURE 9. Double Fourier transform on MFSK signal.

So, observation of the number of spectrum components  $K_{NR}$  in the received signal should allow estimation of the Doppler factor as

$$\mu = \frac{K_N}{K_{NR}}. \quad (6)$$

### C. PILOTS OF MFSK

In the MFSK symbol, 7 carriers are set at the lower end of the allocated spectrum. Since the receiver knows the frequencies at which those pilots were sent and frequencies at which they were received, the Doppler shift can be estimated. The Doppler shift strongly depends on the frequency, and the received frequency  $f'$  can be calculated using the Doppler factor:

$$f' = f \cdot \mu. \quad (7)$$

### D. CROSS-CORRELATION OF RECEIVED AND GENERATED MFSK

The last method of recovering the frequency of the received signal utilizes a cross-correlation function. There is a calculated cross-correlation of a spectrum of the received signal with a spectrum of the generated signal. The generated signal resembles the MFSK, with power set for each carrier representing “0” and “1”. Actually, a bank of such signals is generated for different Doppler factors. By comparing the maximum values of the spectrum, the most likely Doppler factor can be found. It is the one with the highest value of cross-correlation maximum. Then it is used to receive data from the signal.

## IV. MEASUREMENT RESULTS

The results presented below are based on the data obtained from three experiments. For each of them, 6 measurement tests were conducted, and signal recordings were carried out



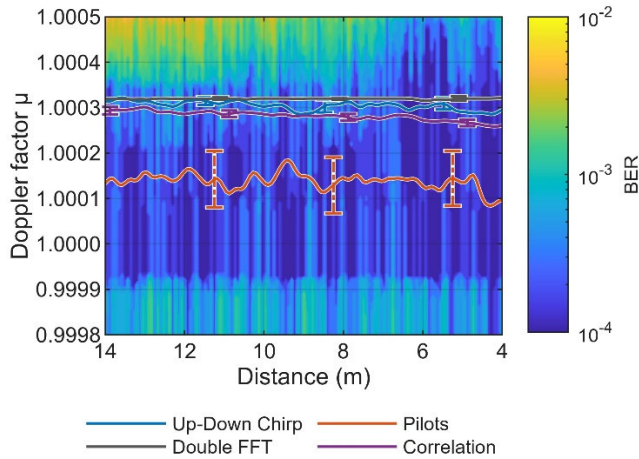

**FIGURE 10.** The value of the  $\mu$  coefficient as a function of the distance between the transmitter and receiver for different methods of determining the Doppler factor for a transmitter moving at 0.5 m/s.

simultaneously with 4 receiving transducers while the transmitting transducer was moving from a distance of 14 meters to 4 meters at a constant velocity. Measurements for the three consecutive experiments were conducted for the transmitter moving at velocities of 0.5, 1 and, 1.5 [m/s] (with an accuracy of  $\pm 0.01$  m/s), respectively. The results were averaged across all receiving transducers and measurement tests. Due to the limited number of measurements, the graphs presented in this chapter were subjected to smoothing filtering as a weighted average of the results in the vicinity of a given measurement point. The weights of the individual values were determined according to a Gaussian window. To evaluate the accuracy of the determined values of the Doppler factor, the BER was determined for each test and transducer, within the range of  $\mu$  from 0.9998 to 1.0015. This process identified the values of  $\mu$  that resulted in the least number of reception errors for each symbol. The heat map of reception quality for matched  $\mu$  is the background for other methods for the Doppler factor evaluation. Furthermore, for each  $\mu$  estimation method, the standard deviation for 3-meter sections was calculated and marked with vertical dashed lines on the chart.

**A. TEST RESULTS FOR TRANSMITTER MOVEMENT AT 0.5 M/S**

The value of the  $\mu$  coefficient as a function of the distance between the transmitter and receiver for different methods of determining the Doppler factor is shown in Fig. 10. The correlation method, double FFT, and the method using chirp signals return very similar values of this coefficient. The double FFT has the smallest deviation of  $\mu$  values at all distances. On top of this, the  $\mu$  coefficient values of these methods are very close to the theoretical value, calculated from the velocity of the transmitter, which was discussed in the second chapter.

The quality of data transmission as a function of the distance between the transmitter and receiver for different methods of determining the Doppler factor is illustrated in Fig. 11. Additionally, dots (in the color of the given curve)

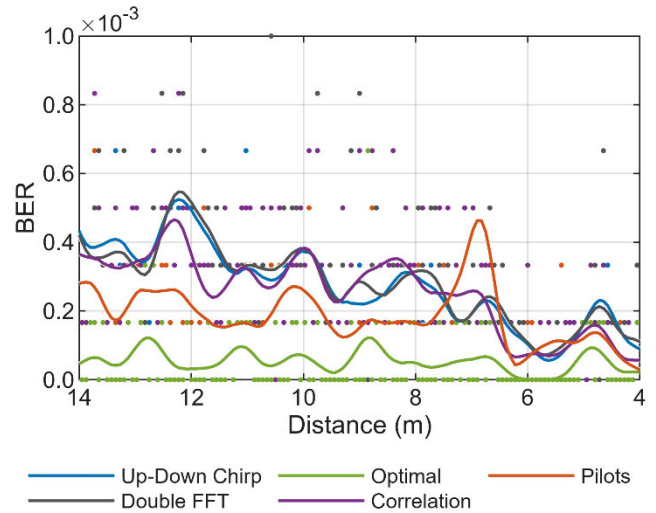
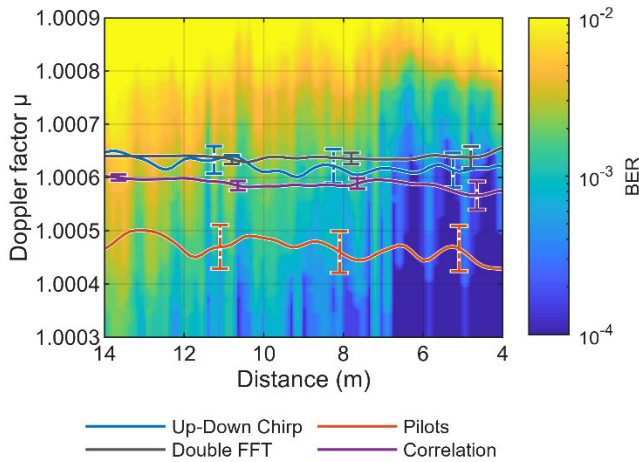

**FIGURE 11.** Data transmission quality as a function of the distance between the transmitter and receiver for different methods of determining the Doppler factor for a transmitter moving at 0.5 m/s.

indicating values before applying the smoothing filter are also plotted. The graph also features a curve representing the minimum possible BER to be achieved assuming an optimal selection of  $\mu$  coefficient values. In this case, a linear scale was used, since, as can be seen from the arrangement of the dots on the graph, there are a few errors in the transmission at particular distances. With such a low velocity of the transmitter, the determination of the  $\mu$  coefficient does not have a critical role in the correct reception of the transmission. It can be seen that double FFT and up-down chirp method give similar results. Results given by the correlation method are also similar, however slightly better, to the double FFT and up-down chirp results as values of  $\mu$  given by those methods are similar. The pilots method provided the lowest values of the BER, with the short rise observed around the 7 m range. The standard deviation of  $\mu$  for the pilots method is the highest, however most of the results fall in the relative optimum  $\mu$  coefficient range (the darker area on Fig. 10).

**B. TEST RESULTS FOR TRANSMITTER MOVEMENT AT 1 M/S**

The value of the  $\mu$  coefficient as a function of the distance between the transmitter and receiver for different methods of determining the Doppler factor for a transmitter moving at a velocity of  $v = 1$  m/s is shown in Fig. 12. Similar to the results obtained for 0.5 m/s, the pilots method gave the lowest values of  $\mu$  coefficient. It is also worth mentioning that the values of standard deviation for this method are similar for 1 m/s and 0.5 m/s, whereas this parameter increased for the remaining methods for 1 m/s. The standard deviation is similar for the double FFT and the correlation methods, and higher for the up-down chirp method. However, still the highest values of standard deviation are for the pilots method. But, due to the  $\mu$  coefficient values near the area where the BER was the lowest, according to the background heat map representing



**FIGURE 12.** The value of the  $\mu$  coefficient as a function of the distance between the transmitter and receiver for different methods of determining the Doppler factor for a transmitter moving at 1 m/s.

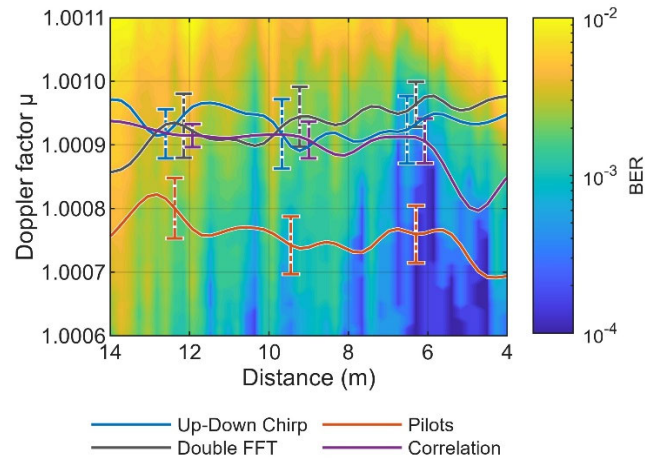

**FIGURE 14.** The value of the  $\mu$  coefficient as a function of the distance between the transmitter and receiver for different methods of determining the Doppler factor for a transmitter moving at 1.5 m/s.

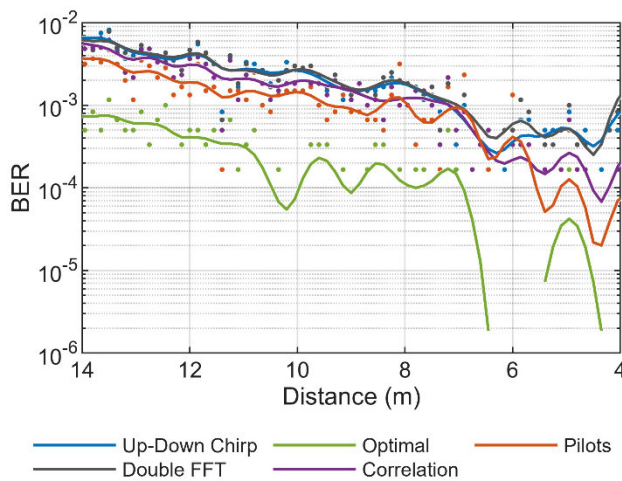

**FIGURE 13.** Data transmission quality as a function of the distance between the transmitter and receiver for different methods of determining the Doppler factor for a transmitter moving at 1 m/s.

BER, the pilots method gave the best quality of data reception among the considered methods.

The quality of data transmission as a function of the distance between the transmitter and receiver for different methods of determining the Doppler factor is shown in Fig. 13. The graph shows line breaks and missing dots for parts of the distance. These are due to zero errors and the logarithmic scale. It can be seen that the larger the distance the greater were values of the BER. The results for distances greater than 7 m for the double FFT and the up-down chirp method are almost the same. For shorter distances, the method utilizing chirp signals enables reception with fewer errors. The lowest BER values, as assumed based on Fig. 12, are for the pilots method. The fluctuations of the BER for the pilots method along distance prove the occurrence of multipath effect.

### C. TEST RESULTS FOR TRANSMITTER MOVEMENT AT 1.5 M/S

The value of the  $\mu$  coefficient as a function of the distance between the transmitter and receiver for different methods of determining the Doppler factor for the transmitter moving velocity of  $v = 1.5$  m/s is shown in Fig. 14. For the higher movement speed, the standard deviation for up-down chirp, double FFT, and correlation methods is significantly higher than for 1 m/s. However, for the pilots method, the increase in standard deviation value is smaller. For this measurement scenario, the lowest values of  $\mu$  coefficient were achieved using the pilots method, which led to the lowest BER results.

The quality of data transmission as a function of the distance between the transmitter and receiver for different methods of determining the Doppler factor for 1.5 m/s transmitter velocity is shown in Fig. 15. Also, for this speed, for distances greater than 7 m, double FFT, up-down chirp, and correlation methods gave similar values of BER. For small distances, the worst method seemed to be double FFT. The pilots method enabled to achieve the best reception quality for all distances.

The comparison of the bit error rate averaged along the entire transmitter path for different methods of determining the Doppler factor for different transmitter velocities is depicted in Fig. 16. It can be seen that each of the methods for determining the  $\mu$  coefficient gives the BER several times worse than the values determined with optimal  $\mu$ . Up-down chirp and double FFT methods gave BER values close to each other, which implies that the methods are comparable in quality. In each case, the best of the two was the method using chirp signals. It is also noticeable that as the velocity increases, the BER also increases, but this is most evident in the jump from 0.5 to 1 m/s. The best reception quality was achieved by utilizing the pilots method.



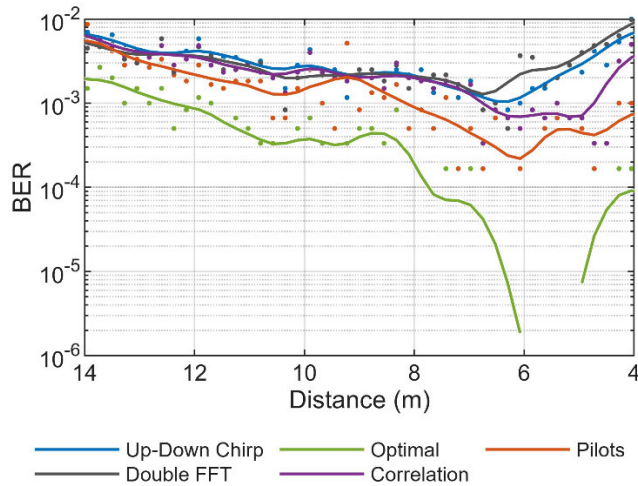

FIGURE 15. Data transmission quality as a function of the distance between the transmitter and receiver for different methods of determining the Doppler factor for a transmitter moving at 1.5 m/s.

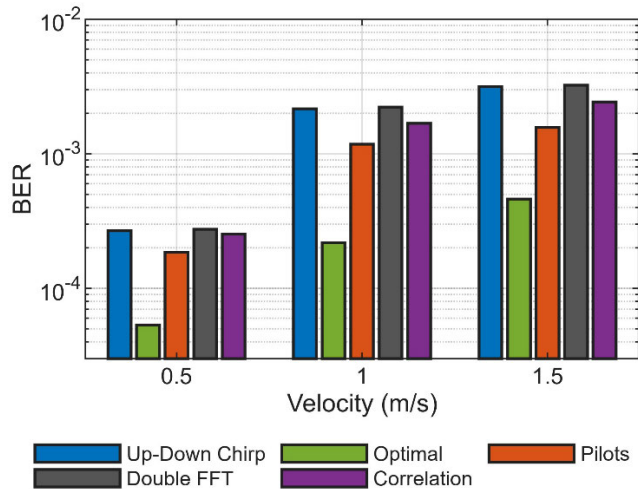

FIGURE 16. BER for the different Doppler factor determination methods and for different transmitter velocities.

TABLE 2. Averaged methods time execution.

Method	Time [ms]
Up-Down Chirp	15.631
Pilots	0.063
Double FFT	0.286
Correlation	0.488

D. COMPUTATIONAL COMPLEXITY

There was also made a comparison of the computational burden of all analyzed Doppler estimation methods. It has been realized by measuring the time of methods execution. Averaged results are presented in Table 2. Each method was executed 1780 times with utilization of Intel Core i9-13980HX 5.6 GHz, 64 GB RAM 5200 MHz.

The pilots method appears to need the least time for execution. The next least time-consuming method is double

TABLE 3. Advantages and disadvantages of each method.

Method	Advantages	Disadvantages
Up-Down Chirp	<ul style="list-style-type: none"> <li>- well known in literature</li> <li>- chirp signals robust to Doppler effect</li> <li>- chirp signals robust to multipath effect</li> </ul>	<ul style="list-style-type: none"> <li>- needs additional bandwidth</li> <li>- computationally complex</li> </ul>
Pilots	<ul style="list-style-type: none"> <li>- simple and computationally efficient</li> <li>- gives the best results</li> </ul>	<ul style="list-style-type: none"> <li>- needs additional bandwidth</li> <li>- single pilot vulnerable to multipath effect (fading)</li> </ul>
Double FFT	<ul style="list-style-type: none"> <li>- does not need additional bandwidth</li> <li>- needs wideband MFSK modulation (if this modulation is used)</li> </ul>	<ul style="list-style-type: none"> <li>- needs wideband MFSK modulation (if another modulation is used)</li> <li>- resolution of this method strongly depends of the distance between the carriers in MFSK signal</li> </ul>
Correlation	<ul style="list-style-type: none"> <li>- does not need additional bandwidth</li> <li>- needs wideband MFSK modulation (if this modulation is used)</li> </ul>	<ul style="list-style-type: none"> <li>- needs wideband MFSK modulation (if another modulation is used)</li> </ul>

FFT, which needs about 4.5 times more time than pilots method. The third least consuming method is correlation, which needs 7.7 times more time than pilots method for execution. Nevertheless, the time consumption for all those three methods is less than 1 ms. The most complex is the up-down chirp method, which needs over 15 ms. It must also be explained that the up-down chirp method was optimized. The matched filter generation is done only once at the beginning of receiver execution as the chirp transmission is always on the same frequencies. The more efficient FFT-based FIR filtering function, using the overlap-add method, is used for matched filtration. However, the long execution time is due to the need for four filtrations – one for each chirp, requiring a matched and lowpass filtration. The correlation method has also been optimized. As the generated benchmark MFSK signal consists of ones on used frequencies and zeros on unused frequencies, the correlation is performed by summing the appropriate spectrum components in the received signal’s spectrum. Naturally, the sliding procedure, as with a real correlation, was taken into account, so there is no need for a multiplication operation.

E. METHODS COMPARISON

In this section, the comparison between analyzed methods is done. It is presented in Table 3 where advantages and disadvantages of each method are discussed.

The best results, according to Fig. 16, were achieved by the pilots method. It is also worth mentioning that this method has the lowest execution time. However, there is a need for additional bandwidth to allocate a couple of pilots to overcome problems caused by fading. The worst results were

obtained with up-down chirp and double FFT methods. Both methods gave very similar results for each considered speed and they were around 1.46 times worse than the pilots method for 0.5 m/s, 1.85 times worse for 1 m/s and 2.03 for 1.5 m/s. The method utilizing chirp signals is the most complex among the analyzed and gave slightly better results than double FFT. The results achieved for the correlation method are 1.36 times worse than the pilots method for 0.5 m/s, 1.43 times for 1 m/s and 1.54 times for 1.5 m/s.

In the up-down chirp method, the main influence on its performance has the multipath effect. Generally, due to the different frequency directions sweeping in these signals, in the estimated impulse response maximum values may correspond to different paths, leading to high errors. The other considered methods work in the frequency domain, where the multipath effect with the Doppler effect only cause spectrum spread of analyzed carriers.

## V. CONCLUSION

Providing reliable wireless underwater communication is a contemporary problem and new solutions are still being sought in this area. In most cases, they are based on the solutions used in radio communication, whereby attempts are being made to adapt them for communication using elastic wave. The water environment is difficult when it comes to the propagation of hydroacoustic waves, which is strongly evident in water bodies with dense hydrotechnical buildings. In those conditions there exists the phenomenon of multipath propagation, which significantly limits the possibility of data transmission. The mutual motion of the transmitter and receiver also has a significant impact, which in turn becomes apparent in the form of the Doppler effect. This article focuses on the evaluation of various methods of determining the Doppler factor in a highly multipath environment. The study was carried out for MFSK modulation and the methods were evaluated on the basis of bit error rate. This problem is very important from the point of view of ensuring a low bit error rate for received data. In this paper, based on laboratory tests on real signals under difficult propagation conditions, four methods for determining the Doppler factor have been compared. Analysis of the results shows that the method using pilots achieves the lowest BER values in reception. The second best method was that using the correlation. The advantage of the correlation method is that, as opposed to the method using pilots, it does not require the allocation of an additional bandwidth. The advantage of the pilot method is that it is less computationally complex than the correlation method. The errors in the determination of the Doppler factor in the chirp-based method are due to the obtained different forms of the impulse response estimates, determined for the Up and Down signals, which did not allow the correct determination of the mutual offset.

In further studies, the authors plan to conduct experiments at higher reciprocal velocities of the receiver and transmitter, as well as using other modulation techniques, e.g. BPSK, LoRa or OFDM.

## ACKNOWLEDGMENT

The authors would like to thank the Faculty of Mechanical Engineering and Ship Technology of the Gdansk University of Technology for the opportunity to conduct research in the towing tank.

## REFERENCES

- [1] L. Ma, H. Jia, S. Liu, and I. Ullah Khan, "Low-complexity Doppler compensation algorithm for underwater acoustic OFDM systems with nonuniform Doppler shifts," *IEEE Commun. Lett.*, vol. 24, no. 9, pp. 2051–2054, Sep. 2020, doi: [10.1109/LCOMM.2020.2998293](https://doi.org/10.1109/LCOMM.2020.2998293).
- [2] T. Ebihara and G. Leus, "Doppler-resilient orthogonal signal-division multiplexing for underwater acoustic communication," *IEEE J. Ocean. Eng.*, vol. 41, no. 2, pp. 408–427, Apr. 2016, doi: [10.1109/OJEO.2015.2454411](https://doi.org/10.1109/OJEO.2015.2454411).
- [3] T. Fang, S. Liu, Y. Liu, B. Wang, and J. Su, "Non-cooperative underwater acoustic MFSK time-frequency representation optimization method based on sparse reconstruction," *Appl. Acoust.*, vol. 214, Nov. 2023, Art. no. 109669, doi: [10.1016/j.apacoust.2023.109669](https://doi.org/10.1016/j.apacoust.2023.109669).
- [4] J. Mizeraczyk, R. Studanski, A. Zak, and A. Czapiewska, "A method for underwater wireless data transmission in a hydroacoustic channel under NLOS conditions," *Sensors*, vol. 21, no. 23, p. 7825, Nov. 2021, doi: [10.3390/s21237825](https://doi.org/10.3390/s21237825).
- [5] Z. Ostrowski, R. Salamon, I. Koczańska, and J. Marszał, "Underwater navigation system based on Doppler shift-measurements and error estimations," *Polish Maritime Res.*, vol. 27, no. 1, pp. 180–187, Mar. 2020, doi: [10.2478/pomr-2020-0019](https://doi.org/10.2478/pomr-2020-0019).
- [6] S. Rong and Y. Xu, "Motion parameter estimation of AUV based on underwater acoustic Doppler frequency measured by single hydrophone," *Frontiers Mar. Sci.*, vol. 9, Nov. 2022, Art. no. 1019385, doi: [10.3389/fmars.2022.1019385](https://doi.org/10.3389/fmars.2022.1019385).
- [7] R. Diamant, A. Feuer, and L. Lampe, "Choosing the right signal: Doppler shift estimation for underwater acoustic signals," in *Proc. 7th ACM Int. Conf. Underwater Netw. Syst.*, 2012, pp. 1–8, doi: [10.1145/2398936.2398971](https://doi.org/10.1145/2398936.2398971).
- [8] B. S. Sharif, J. Neasham, O. R. Hinton, and A. E. Adams, "Doppler compensation for underwater acoustic communications," in *Oceans 99. MTS/IEEE Riding Crest 21st Century. Conf. Exhibition, Conf. Proc.*, Sep. 1999, p. 216, doi: [10.1109/OCEANS.1999.799734](https://doi.org/10.1109/OCEANS.1999.799734).
- [9] K. A. Perrine, K. F. Nieman, T. L. Henderson, K. H. Lent, T. J. Brudner, and B. L. Evans, "Doppler estimation and correction for shallow underwater acoustic communications," in *Proc. Conf. Rec. Forty 4th Asilomar Conf. Signals, Syst. Comput.*, Pacific Grove, CA, USA, Nov. 2010, pp. 746–750, doi: [10.1109/ACSSC.2010.5757663](https://doi.org/10.1109/ACSSC.2010.5757663).
- [10] B. S. Sharif, J. Neasham, O. R. Hinton, and A. E. Adams, "A computationally efficient Doppler compensation system for underwater acoustic communications," *IEEE J. Ocean. Eng.*, vol. 25, no. 1, pp. 52–61, Jan. 2000.
- [11] S. Zhao, S. Yan, and L. Xu, "Doppler estimation based on HFM signal for underwater acoustic time-varying multipath channel," in *Proc. IEEE Int. Conf. Signal Process., Commun. Comput. (ICSPCC)*, Dalian, China, Sep. 2019, pp. 1–6, doi: [10.1109/ICSPCC46631.2019.8960810](https://doi.org/10.1109/ICSPCC46631.2019.8960810).
- [12] R. Wei, X. Ma, S. Zhao, and S. Yan, "Doppler estimation based on dual-HFM signal and speed spectrum scanning," *IEEE Signal Process. Lett.*, vol. 27, pp. 1740–1744, 2020, doi: [10.1109/LSP.2020.3020222](https://doi.org/10.1109/LSP.2020.3020222).
- [13] Q. Jin, K. Max Wong, and Z.-Q. Luo, "The estimation of time delay and Doppler stretch of wideband signals," *IEEE Trans. Signal Process.*, vol. 43, no. 4, pp. 904–916, Apr. 1995, doi: [10.1109/78.376843](https://doi.org/10.1109/78.376843).
- [14] T. Wada, T. Suzuki, H. Yamada, and S. Nakagawa, "An underwater acoustic 64QAM OFDM communication system with robust Doppler compensation," in *Proc. OCEANS MTS/IEEE Monterey*, Monterey, CA, USA, Sep. 2016, pp. 1–4, doi: [10.1109/OCEANS.2016.7761056](https://doi.org/10.1109/OCEANS.2016.7761056).
- [15] M. Johnson, L. Freitag, and M. Stojanovic, "Improved Doppler tracking and correction for underwater acoustic communications," in *Proc. IEEE Int. Conf. Acoust., Speech, Signal Process.*, Aug. 1997, pp. 575–578, doi: [10.1109/ICASSP.1997.599703](https://doi.org/10.1109/ICASSP.1997.599703).
- [16] D. Sun, X. Hong, and H. Cui, "A Kalman-based Doppler tracking algorithm for underwater acoustic spread spectrum communications," *Appl. Acoust.*, vol. 185, Jan. 2022, Art. no. 108374, doi: [10.1016/j.apacoust.2021.108374](https://doi.org/10.1016/j.apacoust.2021.108374).

- [17] B. Li, S. Zheng, and F. Tong, "Bit-error rate based Doppler estimation for shallow water acoustic OFDM communication," *Ocean Eng.*, vol. 182, pp. 203–210, Jun. 2019, doi: [10.1016/j.oceaneng.2019.04.045](https://doi.org/10.1016/j.oceaneng.2019.04.045).
- [18] B. Li, S. Zhou, M. Stojanovic, L. Freitag, and P. Willett, "Multicarrier communication over underwater acoustic channels with nonuniform Doppler shifts," *IEEE J. Ocean. Eng.*, vol. 33, no. 2, pp. 198–209, Apr. 2008, doi: [10.1109/JOE.2008.920471](https://doi.org/10.1109/JOE.2008.920471).
- [19] D. Sun, J. Wu, X. Hong, C. Liu, H. Cui, and B. Si, "Iterative double-differential direct-sequence spread spectrum reception in underwater acoustic channel with time-varying Doppler shifts," *J. Acoust. Soc. Amer.*, vol. 153, no. 2, pp. 1027–1041, Feb. 2023, doi: [10.1121/10.0017116](https://doi.org/10.1121/10.0017116).
- [20] D. Sun, X. Hong, H. Cui, and L. Liu, "A symbol-based passband Doppler tracking and compensation algorithm for underwater acoustic DSSS communications," *J. Commun. Inf. Netw.*, vol. 5, no. 2, pp. 168–176, Jun. 2020, doi: [10.23919/JCIN.2020.9130433](https://doi.org/10.23919/JCIN.2020.9130433).
- [21] C. Baldone, G. E. Galioto, D. Croce, I. Tinnirello, and C. Petrioli, "Doppler estimation and correction for Janus underwater communications," in *Proc. GLOBECOM—IEEE Global Commun. Conf.*, Taipei, Taiwan, Dec. 2020, pp. 1–6, doi: [10.1109/GLOBECOM42002.2020.9348220](https://doi.org/10.1109/GLOBECOM42002.2020.9348220).
- [22] S. F. Mason, C. R. Berger, S. Zhou, and P. Willett, "Detection, synchronization, and Doppler scale estimation with multicarrier waveforms in underwater acoustic communication," *IEEE J. Sel. Areas Commun.*, vol. 26, no. 9, pp. 1638–1649, Dec. 2008, doi: [10.1109/JSAC.2008.081204](https://doi.org/10.1109/JSAC.2008.081204).
- [23] J. Li, Y. V. Zakharov, and B. Henson, "Multibranch autocorrelation method for Doppler estimation in underwater acoustic channels," *IEEE J. Ocean. Eng.*, vol. 43, no. 4, pp. 1099–1113, Oct. 2018, doi: [10.1109/JOE.2017.2761478](https://doi.org/10.1109/JOE.2017.2761478).
- [24] V. D. Nguyen, H. L. N. Thi, Q. K. Nguyen, and T. H. Nguyen, "Low complexity non-uniform FFT for Doppler compensation in OFDM-based underwater acoustic communication systems," *IEEE Access*, vol. 10, pp. 82788–82798, 2022, doi: [10.1109/ACCESS.2022.3196641](https://doi.org/10.1109/ACCESS.2022.3196641).
- [25] D. Sun, J. Wu, H. Cui, Y. Fu, X. Hong, and C. Zheng, "The line-of-sight peak detection and tracking of underwater acoustic DSSS communications in the doubly spread channel," *Appl. Acoust.*, vol. 216, Jan. 2024, Art. no. 109761, doi: [10.1016/j.apacoust.2023.109761](https://doi.org/10.1016/j.apacoust.2023.109761).
- [26] G. Eynard and C. Laot, "Blind Doppler compensation scheme for single carrier digital underwater communications," in *Proc. OCEANS*, Sep. 2008, pp. 1–5, doi: [10.1109/OCEANS.2008.5152066](https://doi.org/10.1109/OCEANS.2008.5152066).
- [27] Y. Liu, Y. Zhao, P. Gerstoft, F. Zhou, G. Qiao, and J. Yin, "Deep transfer learning-based variable Doppler underwater acoustic communications," *J. Acoust. Soc. Amer.*, vol. 154, no. 1, pp. 232–244, Jul. 2023, doi: [10.1121/10.0020147](https://doi.org/10.1121/10.0020147).
- [28] M. Deguchi, Y. Kida, and T. Shimura, "Suppression of effects of Doppler shifts of multipath signals in underwater acoustic communication," *Acoust. Sci. Technol.*, vol. 43, no. 1, pp. 10–21, Jan. 2022, doi: [10.1250/ast.43.10](https://doi.org/10.1250/ast.43.10).
- [29] A. Czapiewska, A. Łukasz, R. Studanski, and A. Zak, "Analysis of impulse responses measured in motion in a towing tank," *Electronics*, vol. 11, no. 22, p. 3819, Nov. 2022, doi: [10.3390/electronics11223819](https://doi.org/10.3390/electronics11223819).
- [30] S. W. Smith, *The Scientist and Engineer's Guide To Digital Signal Processing*. Sacramento, CA, USA: California Technical Pub, 2002.
- [31] T. Nagano, T. Iwamoto, T. Hara, and Y. Takeda, "Range migration compensation for moving targets with unknown constant velocity in chirp radars," in *Proc. 8th Eur. Radar Conf.*, Oct. 2011, pp. 125–128.
- [32] K. Iwashita, T. Moriya, N. Tagawa, and M. Yoshizawa, "Doppler measurement using a pair of FM-chirp signals," in *Proc. IEEE Symp. Ultrason.*, Oct. 2003, pp. 1219–1222, doi: [10.1109/ULTSYM.2003.1293121](https://doi.org/10.1109/ULTSYM.2003.1293121).
- [33] C.-H. Youn, H.-I. Ra, K.-W. Lee, and K.-M. Kim, "Robust underwater acoustic communication using the overlapped chirp spread carrier technique in doubly spread environments," *IEEE Access*, vol. 11, pp. 61412–61421, 2023, doi: [10.1109/ACCESS.2023.3286886](https://doi.org/10.1109/ACCESS.2023.3286886).

**AGNIESZKA CZAPIEWSKA** was born in Inowrocław, Poland, in 1986. She received the master's and Ph.D. degrees in radio communication from Gdańsk University of Technology, in 2010 and 2017, respectively.

Since 2010, she has been with the Department of Radio Communications Systems and Networks, Faculty of Electronics, Telecommunications and Informatics, Gdańsk University of Technology, where she has been an Assistant Professor, since 2017. She has participated in 11 researched and development projects and published 70 papers and articles.

Dr. Czapiewska belongs to the international European Cooperation in Science and Technology (COST) CA20120 INTERACT Group, since 2021. In 2014, she received the second award in Young Authors' Competition for the paper titled "A New Algorithm for Determining the Position of Objects Based on Distance Measurements in the Indoor Environment" presented at the National Conference on Radio Communication, Broadcasting and Television. In 2022, she was awarded with distinction in the competition "Young Scientists" in the Thematic Group "IT and Telecommunications in Electronics" at the National Electronics Conference for the work titled "Data Transmission in a Hydroacoustic Channel in NLOS Conditions." In 2020, she served as an Associate Editor for the COST Proposal Reference OC-2020-1-24737.

**ANDRZEJ ŁUKSZA** was born in Gdańsk, Poland, in 1959. He received the B.Sc. and M.Sc. degrees in electronics from Gdańsk University of Technology, in 1984, and the Ph.D. degree from Gdańsk University of Technology, in 1998.

From 1984 to 1998, he was an Assistant with the Department of Marine Telecommunications, Gdynia Maritime University, Poland. Since 1998, he has been an Assistant Professor with the Department of Marine Telecommunications, Gdynia Maritime University. His research interests include digital signal processing, underwater communication, and neural networks.

**RYSZARD STUDAŃSKI** received the Ph.D. degree from the Faculty of Electronics, Telecommunications and Computer Science, Gdańsk University of Technology, in 2003. He has been an Assistant Professor with the Naval Academy, since 2003, and with Gdynia Maritime University, since 2014. He is interested in the problems of analyzing signals recorded in a wide band.

**ŁUKASZ WOJEWÓDKA** was born in Wejherowo, Poland, in 1998. He received the B.Sc. and M.Sc. degrees in electronics and telecommunications from Gdynia Maritime University, Poland, in 2022 and 2023, respectively, where he is currently pursuing the Ph.D. degree in automation, electronics, electrical engineering and space technologies.

Since 2023, he has been an Assistant with the Department of Marine Telecommunications, Gdynia Maritime University. His research interests include underwater communication and cybersecurity.

**ANDRZEJ ŻAK** was born in Warsaw, Poland, in 1977. He received the M.Sc. (Eng.) degree in information technology from the Military University of Technology in Warsaw, in 2001, the Ph.D. degree in mechanical engineering from the Polish Naval Academy, in 2006, and the Habilitated Doctor degree in technical sciences in the field of automation and robotics, with a specialization in autonomous underwater vehicles from the AGH University of Science and Technology, in 2015.

Since 2003, he has been with the Polish Naval Academy, first with the Hydroacoustics Department and currently with the Information Technology Department, as an Associate Professor and the Head of Department. He has participated in more than 20 research and development projects, including international and published more than 100 papers and articles. His research interests include passive observation of the physical fields of ships, especially hydroacoustics. In recent years, he has concentrated on underwater wireless communications using elastic waves in hard propagation conditions.

...

