

DIGITAL WAVEGUIDE MODELS OF THE PANPIPES

A. CZYŻEWSKI, J. JAROSZUK and B. KOSTEK

Sound & Vision Engineering Department,
Gdańsk University of Technology, Gdańsk, Poland
Narutowicza 11/12, 80-952 Gdańsk, Poland
kido@sound.eti.pg.gda.pl

The aim of this paper is to present a digital waveguide model of the Panpipes. For the efficient modelling of the Panpipes instrument its structure and its physics were studied and discussed. Principles of the digital waveguide modelling of woodwind instruments were also briefly reviewed. In the paper two digital waveguide models of Panpipes instruments differing from each other in their complexity were presented. Consequently it enabled studying the influence of the decreasing complexity of the model on the resulting synthetic sound quality. The subjective tests performed showed that the simplifications in digital waveguide models introduced reveal no noticeable influence on the sound quality. Comparison of synthetic and real Panpipes sounds was also made and conclusions reached.

1. Introduction

Sound synthesis is the process of generating acoustical signals based on a set of various parameters. The perfect example of a sound synthesiser is the human voice. Also, all the acoustic instruments can be considered to be sound synthesisers, although the human voice, sound of a violin, clarinet, etc. represent natural synthesisers, as opposed to the sounds achieved using modern electronic synthesisers.

The expansion of digital techniques has led to the development of the sound synthesis techniques based on the digital description of the signals. The physical modelling techniques are a special group of digital methods. They are focused on the structure of the particular instrument and on all the physical phenomena involved in the natural sound generation process. The technique called digital waveguide modelling is a simplified version of mathematical modelling. It is also based on the wave equation describing propagation of acoustic waves in a particular medium. This method usually handles sound generation in real-time. Although the significant simplifications are made in the modelling process, it still retains good quality and reality of synthetic sounds.

2. Digital waveguide modelling

Assuming that a plane acoustic wave is being propagated along a lossless, infinite tube the one-dimensional wave equation can be presented as follows:

$$\frac{d^2 p}{dt^2} = c^2 \frac{d^2 p}{dx^2}, \quad (1)$$

where c — sound velocity in air [m/s], p — acoustical pressure [Pa], t — time [s], x — distance along the pipe [m].

Transforming the general solution of the equation (1) [2, 5, 6, 11] into a digital domain with a specified sampling frequency (taking into consideration the Nyquist frequency [9, 10]), leads to digital representation of travelling waves that can be easily implemented using a standard digital waveguide structure [11]:

$$p(t_n, x_m) = p^+(n - m) + p^-(n + m). \quad (2)$$

The general class of solutions to the lossless, one-dimensional, second-order wave equation describing the air column system of the tube can be expressed as:

$$x(l, t) = x_r(l - ct) + x_l(l + ct) \quad (3)$$

where $x_r(l - ct)$ — right-going travelling waves, $x_l(l + ct)$ — left-going travelling waves, c — propagation velocity, l — position.

3. Digital waveguide models of the panpipes

A Panpipe belongs to the group of woodwind instruments. It is one of the oldest instruments, and consists of a set of hollow tubes (reeds or bamboo tubes, canes). The instrument is formed by joining the tubes together in a concave curve (as viewed by the player) and setting them on a wooden base. The longest tube is at one end. Each successive tube is slightly shorter than its neighbour, allowing an array of pitches from low to high. As the tubes become shorter they also become narrower. A shorter tube produces a higher pitch. The player blows into the top open end of the tubes. The other end of the tube is usually closed. The tube bottoms are plugged with either cork or wooden dowels and then further sealed with a plug of beeswax. The beeswax enables the Panpipes to be tuned by either removing some of the wax or inserting and pressing additional wax. Some of the above characteristics can be seen in Fig. 1.

The Panpipes are a set of cylindrical tubes, which means that their diameter does not change along the tube. There is no need to model the shape of the bore in view of the simplicity of the real instrument, thus the modelling process of the Panpipes bore can be simplified as proposed in the literature [1, 2].

Two digital waveguide models of the Panpipes were engineered. They differ from each other in their complexity. The strategy behind the so-called “physical” model was to design all essential components of the real instrument in order to produce a synthetic sound perceived subjectively as close to the real one. On the other hand, a “quasi-physical” model should provide an acceptable synthetic sound but the constraint should be put on the simplicity of the design. The models were implemented employing a digital signal processor using *SynthBuilder* software on the Next workstation. This application enabled the modelling of pipe according to the algorithm described before. The models were created on the basis of the digital waveguide models of musical wind instruments as proposed in literature [1, 2, 3, 11].

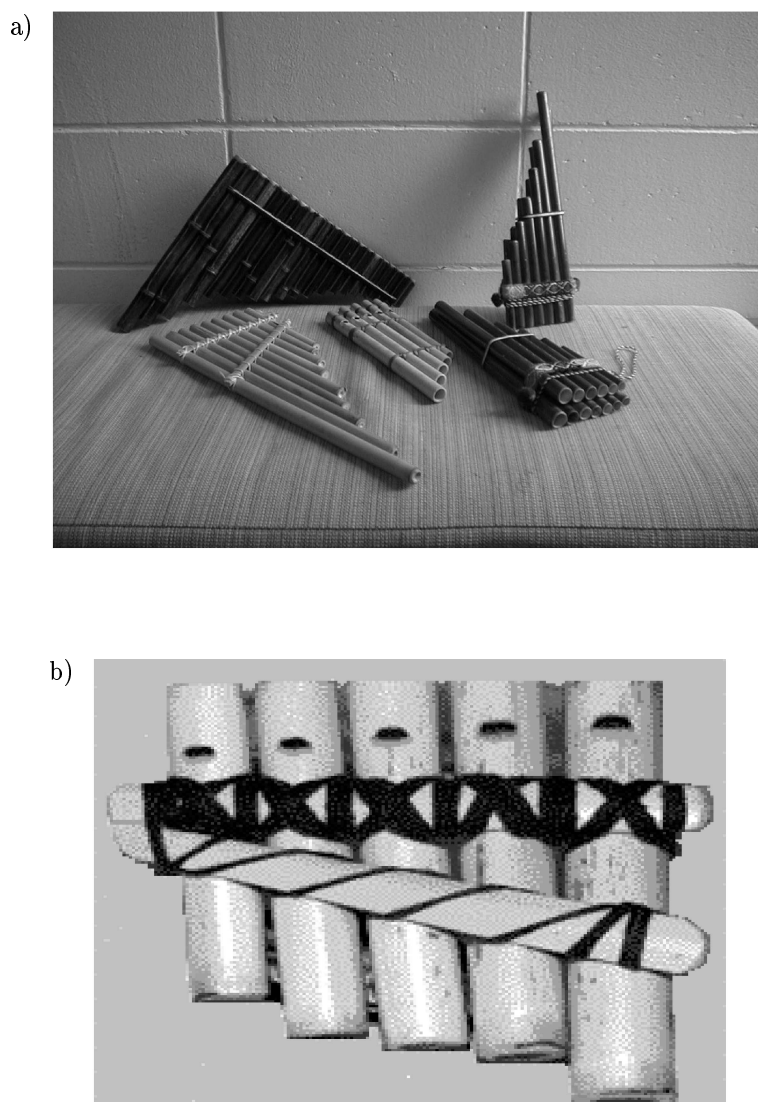

Fig. 1. Examples of Panpipes instruments [12].

3.1. "Physical" Digital Waveguide Model of the Panpipes

The engineered "physical" digital waveguide model of the Panpipes is presented in Fig. 2 and its implementation in Fig. 3. Figure 3 shows the block diagram of this model constructed with the use of *SynthBuilder* tools. It is possible to run this algorithm in real time on a single DSP chip (Motorola 56001). It consists of three basic parts: bore model, jet propagation model, jet-bore interaction model.

3.1.1. The Bore Model

The bore of a single pipe was modelled as proposed in the work of one of the authors [7]. The length of the delay line (dl2, see Fig. 1), depending on the expected fundamental frequency of the synthetic sound was computed. Length of the delay lines corresponds to the effective length of the tube. The absolute values of the scaling elements were achieved in the tuning process: $g_1 = -0.9403$, $g_2 = -0.97$, $g_3 = 0.03$. The phase relations between the direct and reflected waves (at the open and closed end of the bore) strictly determine the sign of each value of the g coefficient. The g_1 coefficient enables control of the phase relations and causes generation of odd multiples of a fundamental mode only. The g_2 scaling simulates the phase inversion and the coupling between the travelling waves and the air jet. The FGP (high pass filter) and FDP (low pass filter) were implemented as the simple one-pole IIR filters [7]. They simulate reflections of the travelling waves losses and the dispersive characteristics of the air column together with the reflections.

3.1.2. Jet Propagation Model

The jet propagation model was implemented in its simplified version [2]. In the real instrument a transverse wave is generated in the air jet and gains along its way to the bore edge. This corresponds to the non-linear interaction between the air jet produced by the player and the instrument edge. The amount of the delay δ of the transverse wave can be computed according to a simple principle, namely the increase of air pressure decreases the delay δ (see Eq. (4)), which corresponds to the increase of the velocity of the transverse wave propagation. The effect is that modulation of the $P(t)$ pressure signal (see Fig. 2) causes changes in the musical articulation (tremolo, vibrato, and fundamental frequency changes) that are produced in a real instrument analogously. However, in the model implementation, this non-linear process was simplified and resulted in a linear function $y = a \cdot x + b$ (where y corresponds to the coefficient that scales the length of the delay line (dl1, see Fig. 2), x corresponds to the signal $P(t)$ simulated in the model, $a = -1.059701$ and $b = 0.361194$ are coefficients well-chosen to achieve the expected changes of the fundamental frequency in the full range of $P(t)$ signal changes. The transverse wave gain is simulated by multiplying the non-linear element output by a value proportional to the $P(t)$.

The delay δ of the transverse wave is described as:

$$\delta = \frac{l}{0.5V} = l \sqrt{\frac{2\rho}{P(t)}}, \quad (4)$$

where l — length of the “air jet” (distance between the player’s lips and the bore edge), V — flow velocity of the transverse wave, ρ — air density, $P(t)$ — air pressure.

3.1.3. Jet-Bore Interaction Model

The jet-bore interaction model used in the model is similar to the interaction model proposed by Fletcher and Rossing [4]. The non-linear, sigmoid function describing the interaction was implemented using a polynomial approximation: $y = a_1x + a_2x^2 + a_3x^3$,



presented in Fig. 2 (physical model), although the jet model is simplified and the articulation effects (tremolo, vibrato) are produced using some additional LFO generators. The tremolo effect is achieved by modulating the amplitude of the output signal and the vibrato effect is achieved by modulating the delay line length, which produces the effect of cyclic fundamental frequency changes (see Fig. 5). Since these models are similar, only the most important parameters of the “quasi-physical” model will be listed. The values of the scaling coefficients are: $g_1 = -0.94$, $g_2 = -0.08$, $g_3 = 1$. These values were achieved in the tuning process. The interaction between the jet and bore was achieved

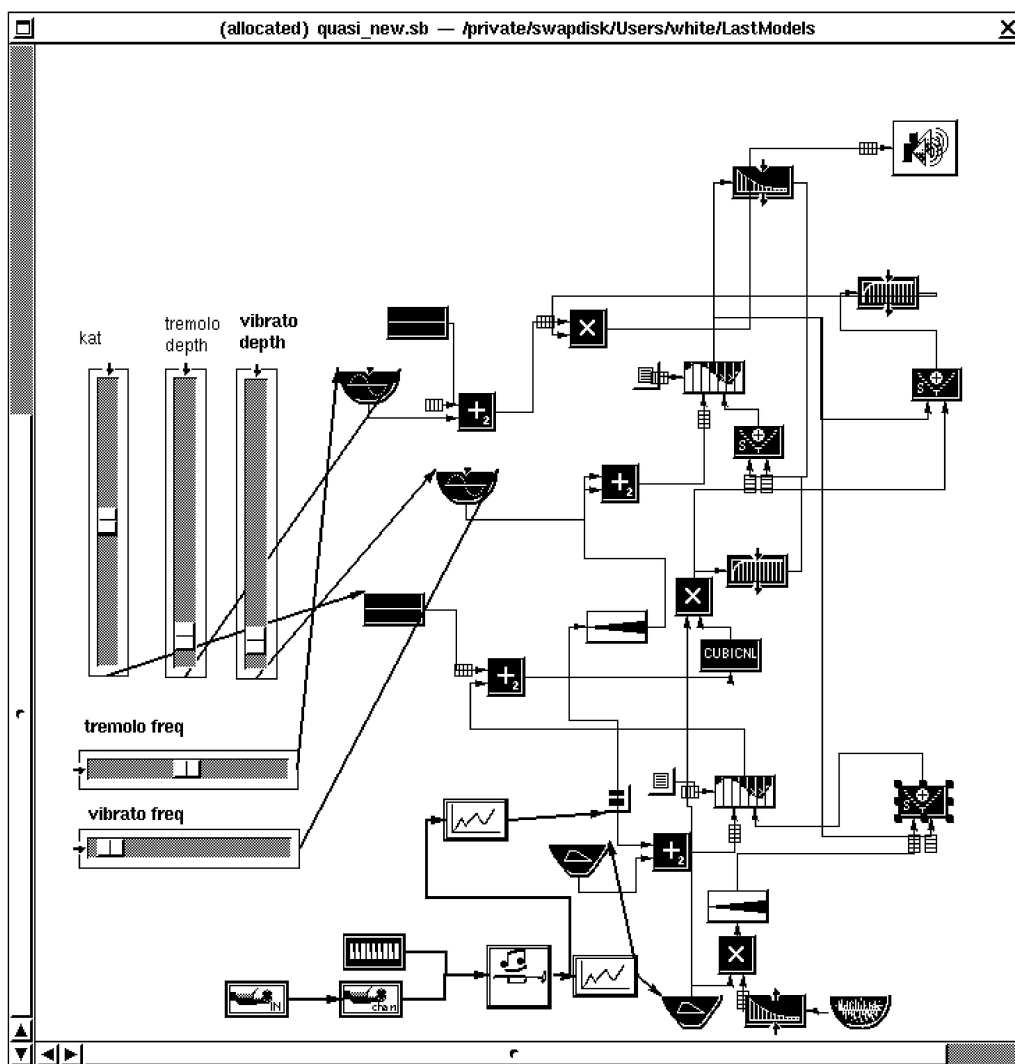

Fig. 6. “Quasi-Physical” Panpipes Digital Waveguide Model implementation in the *Synthbuilder* environment.

using polynomial approximation (as above) with the coefficients: $a_1 = 1$, $a_2 = -0.014925$, $a_3 = -0.402985$. The model and its parameters were also controlled using the master MIDI keyboard.

4. Results of the simulations

The next step of the experiments carried-out was to check performance of models employing some objective and subjective auditory tests. The goal of the analyses was to compare the quality of the synthetic sounds generated by both models. Time domain analyses show that the “physical” model responses introduced for the different musical performance dynamics are closer to the real Panpipes sounds than these achieved using the “quasi-physical” model. Both models can change the attack time of the output signal according to the velocity changes, but only the “physical” model can change dynamics of the output signal and produce the overshoot effect depending on the velocity changes.

4.1. Spectral Analyses

Spectral analyses of the synthetic signals proved that the synthetic sounds spectrum is dominated by odd harmonics, which is a characteristic feature of the instruments such as the Panpipes (built of pipes with only one open end). In Fig. 7 sample analyses are shown allowing for comparison of real and synthetic sound spectra. On the other hand, in Fig. 8 attack transients are shown for both waveguide models. It may be noticed that only in the case of a “physical” model is the overshoot seen in the starting transient of the

a) real sound

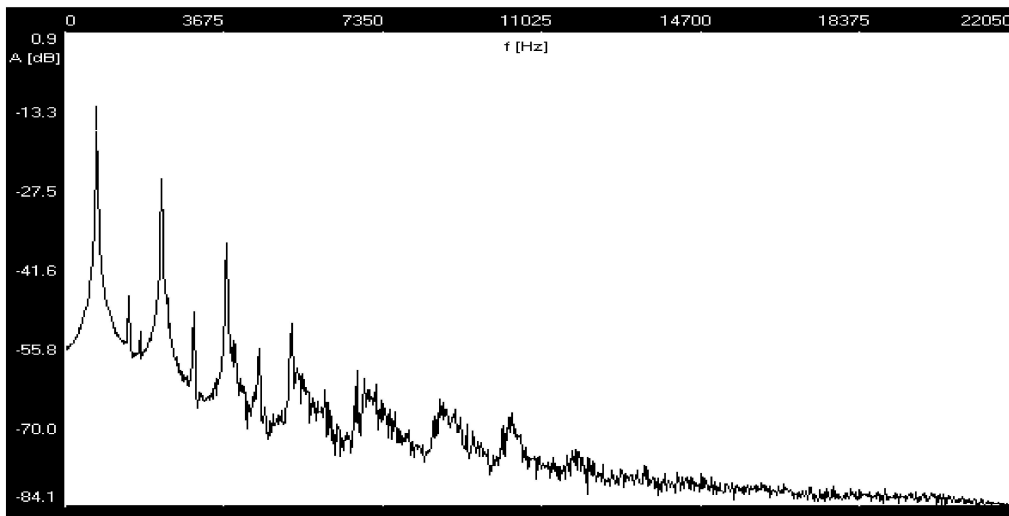
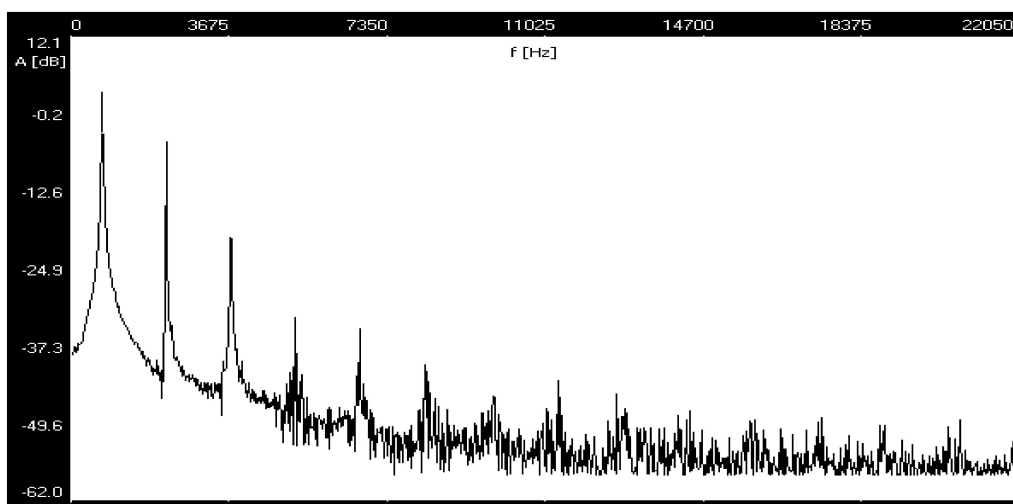

Fig. 7a

b) synthetic — “physical” model



b) synthetic — “quasi-physical” model

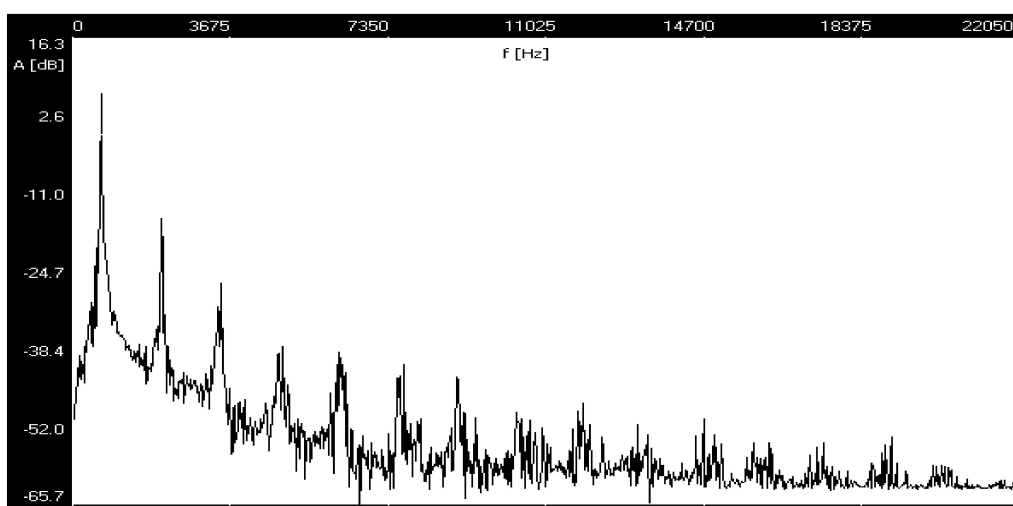
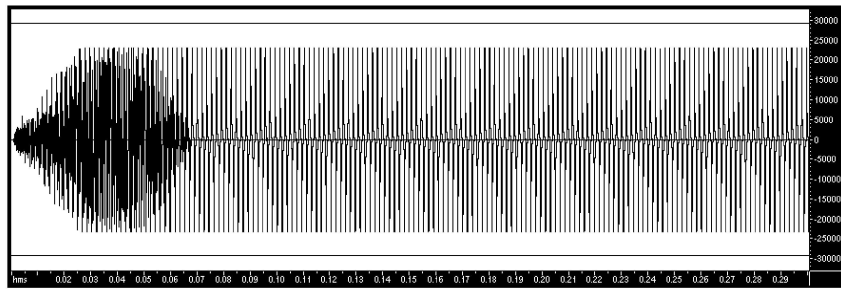

Fig. 7. Samples of Panpipes sound spectra.

synthetic sound. This was obtained for the highest value of the $P(t)$ signal which may be translated as high velocity value applied on the keyboard (see Fig. 9). As seen from Fig. 9 the DC value of $P(t)$ signal increases with the velocity of key pushing. However, this interaction is not linear. Overshoot is also visible in the sonogram presented in Fig. 10a. The “quasi-physical” model does not simulate such articulation effects because of the simplifications described above (Fig. 10b).

a)



b)

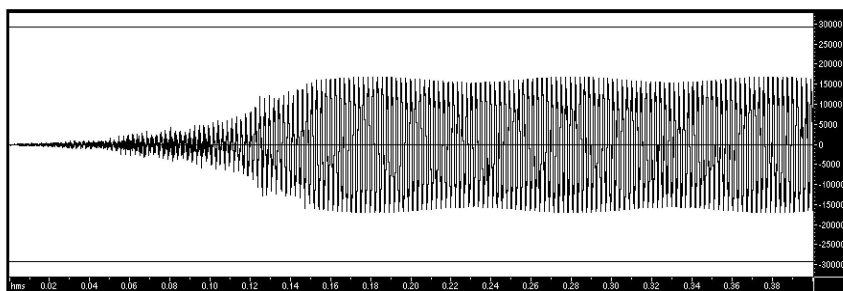

Fig. 8. Attack transients presentation: “physical” model (a), “quasi-physical” model (b), time scale: 0–0.4 [s], *velocity* is equal to 127.

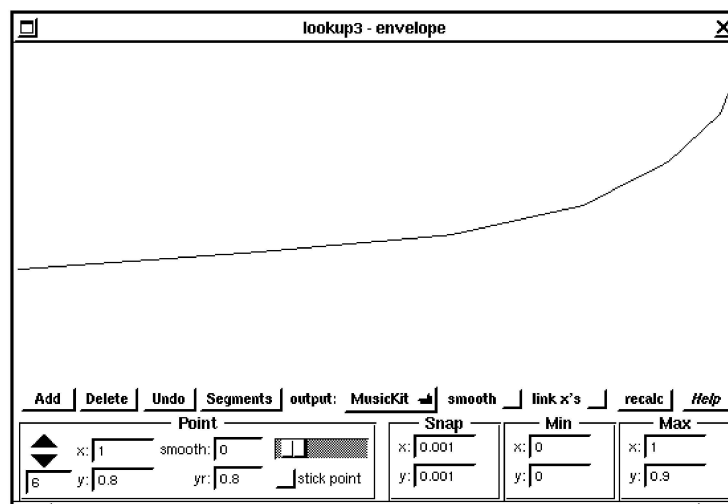

Fig. 9. Look-up table for $P(t)$ signal in function of velocity.

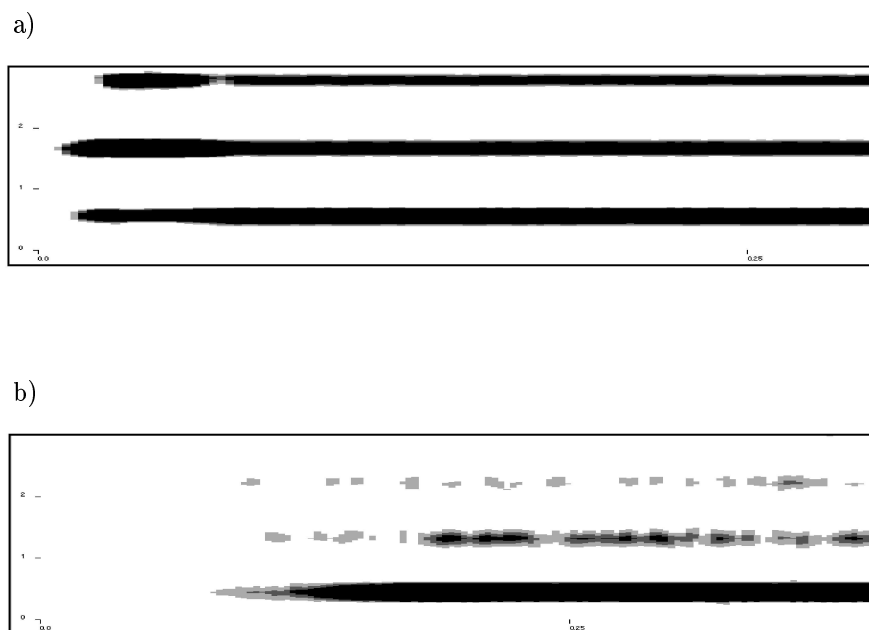

Fig. 10. Sonograms corresponding to attack transients: “physical” model (a), “quasi-physical” model (b), time scale: 0–0.4 [s], velocity is equal to 127.

4.2. Subjective Auditory Tests

The parametric auditory tests [8] were carried out to investigate the differences between the quality of the synthetic sounds achieved using both models (see Tab. 1). They were also focused on verifying the optimum values of the parameters of the models (noise signal levels, nominal value of the air pressure signal and cut-off frequencies of the filters). Thirteen experts were involved in the tests. The synthetic sounds were presented in pairs along with the appropriate natural sounds of the Panpipes. Parameters of the models were assessed in 1–5 point judgement scale. The scores significantly reduced while changing the values of the parameters of the models from their optimum values. In addition, the Fisher test [8] was performed to identify the significant differences between

Table 1. Test questionnaire

Evaluation/scores	Sound quality as compared to real sound
5	Excellent (no distortions or imperceptible)
4	Very good (distortions perceived but not important)
3	Good (distortions perceived but tolerable)
2	Fair (high level of distortions but possible) little distorted
1	Bad (distortions not accepted)

the average values of the judgements assigned to the objects of the test, which allowed identification of the range of the optimum values of each model parameter. In Figs. 11-13 results of parametric test analyses are shown. Figures contain comparison of results obtained for “physical” and “quasi-physical” models.

In Figs. 11-13 mean values referring to the quality of synthetic sounds as evaluated by experts are presented along with standard deviations. The influence of the noise signal level on the quality of the synthetic sound is seen in Figs. 11a and 11b. The quality of the synthetic sound was perceived as too distorted above the value of 0.6 (“physical” model). This was caused by too many noise partials in spectrum. On the other hand, in the case of the “quasi-physical” model the maximum score was obtained for the value of 0.6. For other values of noise signal level (with the exception of the 0.8 value) the sound was perceived as too distorted.

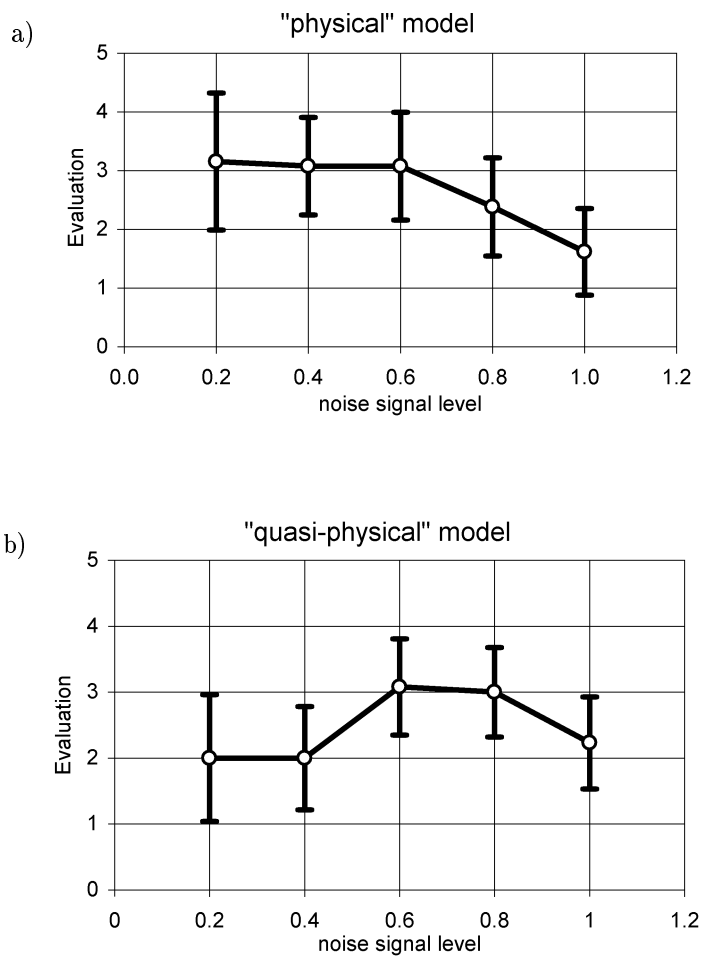

Fig. 11. Comparison of parametric test analyses obtained for “physical” (a) and “quasi-physical” models (b) — searching for the optimum value of noise signal levels.

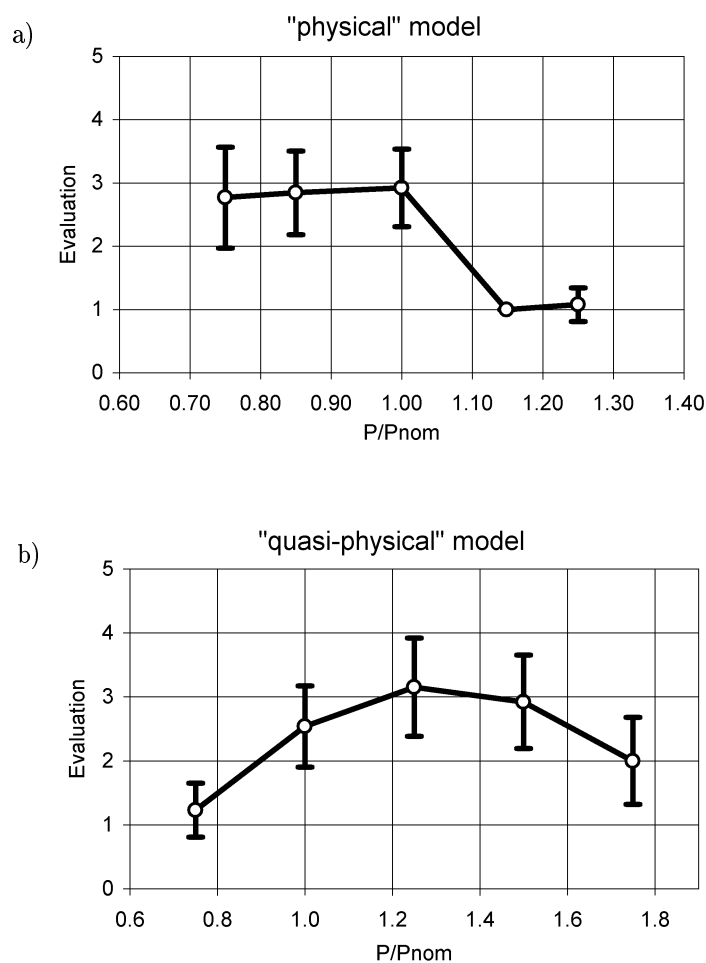

Fig. 12. Comparison of parametric test analyses obtained for "physical" (a) and "quasi-physical" models (b) — searching for the optimum nominal value of the air pressure signal.

The synthetic sound quality was perceived as good for the nominal value of the air pressure signal (Fig. 12a, b). This happened for the "physical" model. On the other hand, for the "quasi-physical" model values higher than the nominal air pressure value, obtained better ratings. As seen in Fig. 13a increasing the cut-off frequency above the nominal value of f_c equal to 5361 Hz causes a decrease in sound quality. On the other hand, decrease of the cut-off frequency up to 4000 Hz does not cause significant decrease in sound quality. Further decreasing of the cut-off frequency causes distortions that are no longer acceptable. The same mean score was obtained for the cut-off frequency equal to 5361 [Hz] for the "quasi-physical" model (Fig. 13b). However, in this case all scores obtained for values other than that of the nominal cut-off frequency were much worse. Moreover a poor uniformity of experts' ratings should be taken into consideration.

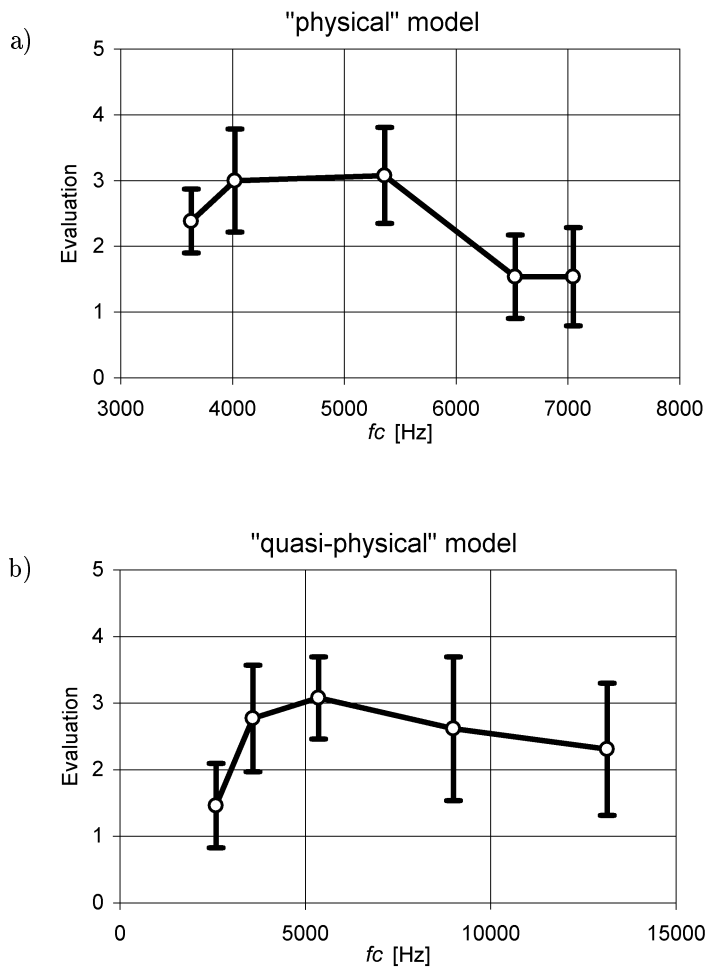

Fig. 13. Comparison of parametric test analyses obtained for "physical" (a) and "quasi-physical" models (b) — searching for the optimum value of cut-off frequencies of the filters.

5. Conclusions

Two digital waveguide models of the Panpipes have been proposed in this paper. Both objective analyses and parametric subjective auditory tests have shown that sounds achieved using the digital waveguide models of the Panpipes are very realistic and acceptable as to quality. The "physical" model in particular was found to be able to produce very realistic articulation effects. Engineered models, even if not taking into account in full, the interaction of all instrument elements, produce sounds that are very similar to the natural sounds of the Panpipes.

Although both models differ from each other in their complexity, their quality was assessed by experts as almost equal. This proves that some simplifications can be per-

formed in a “physical” model with no significant influence on the synthetic sound quality. However, it should be noticed that only single pipes were modelled here. Taking into consideration the interaction between sounds and vibrations coming from various pipes at the same time the complexity of the models would increase significantly. The computational expense of such a model would be too high for performing in real-time, so any possibility of simplifying the model is valuable.

References

- [1] A. CZYŻEWSKI, J. JAROSZUK and B. KOSTEK, *Digital Waveguide Models of the Panpipes*, ISMA2001, Perugia, Italy, 21-24 September (2001).
- [2] A. CZYŻEWSKI, B. KOSTEK and S. ZIELIŃSKI, *Synthesis of organ pipe sound based on simplified physical models*, Archives of Acoustics, **21**, 2, 131–147 (1996).
- [3] A. CZYŻEWSKI, B. KOSTEK and S. ZIELIŃSKI, *New approach to the synthesis of organ pipe sound*, 98th AES Convention, Preprint No. 3957 (E2), Paris, France, 25-28.2. (1995).
- [4] N.H. FLETCHER and T.D. ROSSING, *The physics of musical instruments*, Springer-Verlag, New York 1991.
- [5] R. HÄNNINEN and V. VÄLIMÄKI, *An improved digital waveguide model of a flute with fractional delay filters*, Nordic Acoustical Meeting, Helsinki, 12–14 June (1996).
- [6] M.E. MCINTYRE, R.T. SCHUMACHER and J. WOODHOUSE, *On the oscillations of musical instruments*, J. Acoust. Soc. Am., **74**, 5, 2190–2202 (1992).
- [7] J. JAROSZUK, *Digital waveguide modeling of wind instruments acoustics* [in Polish], M.Sc. Thesis, Sound & Vision Engineering Department, Technical University of Gdansk, Gdansk 2000.
- [8] B. KOSTEK, *Soft computing in acoustics*, Physica-Verlag, Heidelberg 1999.
- [9] P. LANSKY, K. STEIGLITZ, *EIN: A signal processing scratchpad*, Computer Music Journal, **19**, 3, 18–25 (1995).
- [10] M. RUSS, *Sound synthesis and sampling*, Focal Press, (1998).
- [11] J.O. SMITH III, *Digital waveguide modeling of musical instruments*, An Expansion of the Paper: Physical Modeling Using Digital Waveguides, Computer Music Journal, **16**, 4, 74–91 (1992).
- [12] <http://www.engineering.usu.edu/ece/faculty/wheeler/NIU/>