

Zygmunt GIĘTKOWSKI*, Krzysztof KARWOWSKI*, Mirosław MIZAN**, Przemysław PAZDRO*

*GDAŃSK UNIVERSITY OF TECHNOLOGY, FACULTY OF ELECTRICAL AND CONTROL ENGINEERING, DEPARTMENT OF ELECTRIC TRACTION

**GDAŃSK UNIVERSITY OF TECHNOLOGY, FACULTY OF ELECTRICAL AND CONTROL ENGINEERING, DEPARTMENT OF THEORETICAL ELECTROTECHNICS AND INFORMATICS

Review of Research and Development on the Technical Diagnostics in the Field of Electric Traction

Dr inż. Zygmunt GIĘTKOWSKI

He working in the Chair of Electric Traction of the Faculty of Electrical and Control Engineering at the Gdańsk University of Technology. Here he graduated (MS - 1972, Ph.D. - 1981) in electrical engineering. His specialization is electric traction. His current scientific interests concern the technical diagnostics of electric traction catenary. He is co-author of the application diagnostic system (DST), used of the total field of Polish State Railways.

zygiet@ely.pg.gda.pl

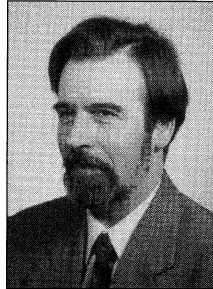

Dr hab. inż. Krzysztof KARWOWSKI, prof. nadzw. PG

He received the S.M. degrees in 1975 and 1981, in electrical engineering from Gdańsk University of Technology (GUT) and in mathematics from Nicolaus Copernicus University, respectively. He obtained his Ph.D. degree in 1984 and D.Sc. degree in 1996, both in electrical engineering from GUT. From 1975 he works in the Faculty of Electrical and Control Engineering of GUT. Since 2000, he has been with the Chair of Electric Traction of GUT, where he is an associate professor. His research interests are in permanent-magnet synchronous machines for a variety of application, industry electronics and diagnostic of traction equipment.

kkarwow@ely.pg.gda.pl

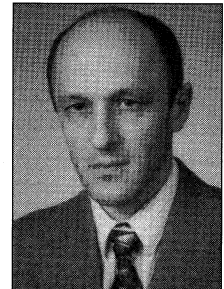

Dr inż. Mirosław MIZAN

He was born in Gdańsk, Poland, in 1958. He received the M.S. and Ph.D. degrees in electrical engineering from Gdańsk University of Technology (GUT), Poland, in 1982 and 1991 respectively. Since 1982 he has been with the Faculty of Electrical and Control Engineering of GUT, where he is currently an Assistant Professor. He is author and co-author of over 50 scientific papers. His research interests include micro-processor control of electrical drives and modern diagnostic methods in electric traction.

mmizan@ely.pg.gda.pl

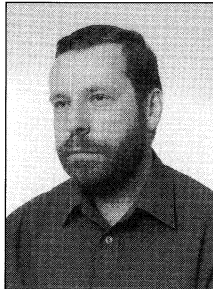

Prof. dr hab. inż. Przemysław PAZDRO

Head of the Chair of Electric Traction in the Faculty of Electrical and Control Engineering at the Gdańsk University of Technology. His specialization is electric traction and rail transport automation. He also works as a Technical Consultant for Warsaw Metro and the Municipal Public Transportation Department of Gdańsk. He graduated in electrical engineering from the Technical University of Warsaw and began working at the Gdańsk University of Technology in 1956, where he obtained a D.Sc. degree. He became a professor in 1988.

pazdro@ely.pg.gda.pl

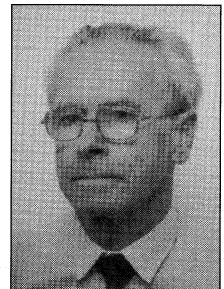

Abstract

The diagnostic tasks, provided measurements and specialised equipment of stationary test stand for checking of EU-07 locomotives are presented. For diagnostics of current collectors new method is proposed, which use special prepared overhead line section on depots exit track. For overhead catenary diagnostics the complex system consisted of special test carriages and stationary data processing stations is developed. Most of essential catenary parameters are measured by the test run and then evaluated by specialised software.

Streszczenie

Przedstawiono funkcje i oprzyrządowanie stańowiska diagnostycznego do badania lokomotyw serii EU07. Jako przykład opisano przebieg testu nastaw wyłącznika szybkiego. Zaproponowano nową metodę kontroli charakterystyki statycznej odbieraka prądu. Badanie przeprowadza się na specjalnie przygotowanej sekcji sieci trakcyjnej na torze wyjazdowym lokomotywowni. Ocenie podlega przebieg siły oddziaływania przewodu jezdno na wysięgnik specjalnego słuca pomiarowego, wywołanej naciskiem odbieraka na sieć. Przedstawiono kompleksowy system diagnostyki sieci jezdnej DST. W jego skład wchodzi 3 specjalne wagony pomiarowe, dokonujące pomiaru istotnych parametrów sieci podczas przejazdów diagnostycznych, oraz kilka stacjonarnych stacji przetwarzania danych. Dzięki utworzeniu specjalnej lokalizacyjnej bazy danych, automatycznie korygującej lokalizację punktów podwieszenia sieci, rozwiązano problem ich niedoskonałej detekcji, występującej przy wszystkich stosowanych w świecie metodach.

Keywords: Electric traction, operating, technical diagnostics

Słowa kluczowe: Trakcja elektryczna, eksploatacja, diagnostyka techniczna

1. Introduction

Technical diagnostics as conception of improvement of the railway systems operation and maintenance has appeared in years seventies

[1]. The electric traction team of Faculty of Electrical Engineering Gdańsk University of Technology (GUT) started the works on this field by elaboration and construction of measurement equipment for overhead contact line inspection railway car - fig. 1 [2].

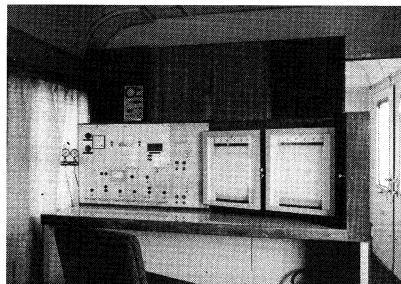

Fig. 1. Control room of first overhead line inspection car
Rys. 1. Stanowisko operatorskie w pierwszym wagonie diagnostycznym sieci jezdnej

The analogue arrangement enabled measurement of overhead line geometry with indication of supports, distance, contact and so named "hard points". This car was in operation on Polish State Railways (PKP) over fifteen years and then was replaced by three new carriages with contemporary generation equipment described later in this article.

Next step on the way of diagnostics development was elaboration of test equipment for electric locomotives.

2. Diagnostics system for electric locomotives

As object of diagnostics one of the most popular machine series EU 07 was indicated by PKP-administration. This is the classic locomotive with resistor, contactor control.

The tasks of diagnostics are as follows: evaluation and classification of locomotive equipment technical state, fast detection and localisation of failures, data collection for forecasting of maintenance requirements.

The conception of stationary test stand called LOKTEST 07A was chosen as most universal [3]. The following measurements are provided: on board battery test, main circuit control sequence verification, chosen contactors switch on/off time control, measurement of main circuit resistors sections resistance, measurement of overcurrent protection apparatus setting (high speed circuit breaker and overload relays).

The tests are leaded automatically under control of microcomputer. It was necessary to elaborate some special interface equipment to joint microcomputer input-output system with locomotive circuits, with full galvanic separation. For example: transistor switches (outputs to locomotive control circuits), optocoupler logic transmitters (input logic signals), analogue-analogue transducers, special low voltage, high current thyristor feeder (0-2 kA), resistance measurement equipment. Some additional installations with special connectors were also provided in control scheme of locomotive.

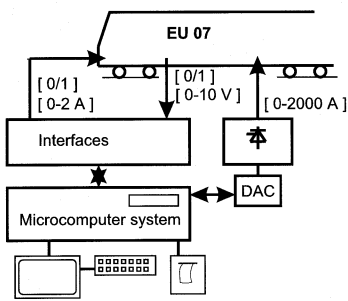

The general block scheme of equipment is shown on fig. 2.

Fig. 2. Block scheme of diagnostics system LOKTEST 07A
Rys. 2. Schemat blokowy systemu diagnostycznego LOKTEST 07A

As an example the test of high-speed breaker setting may be described. The high current feeder is connected to overcurrent release coil by means of flexible cables with clamp tips. The thyristor feeder is controlled by analogue circuit but DAC enables its control from microcomputer system. At first current quickly rise to the expected level of detection and then slowly to assure high accuracy of measurement. At the moment when the breaker switches off, the signal from auxiliary contact is send to the test system and the value of measured current is recorded. At this moment the feeder is automatically switched off. The recorded value is compared with nominal data and the result is displayed as correct or no correct evaluation.

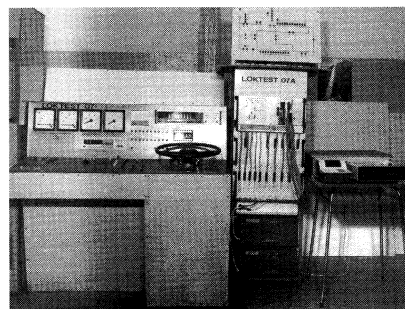

The diagnostic station LOKTEST 07A - fig. 3, is still working in PKP depot in Gdynia.

Fig. 3. Equipment of diagnostic station of electric locomotives
Rys. 3. Wyposażenie stanowiska diagnostycznego lokomotyw elektrycznych

3. Operational technical diagnostics of current collectors

The problem of current collection from the overhead line by the electric locomotives and ElectroMotiveUnits (EMU) is essential for the electric traction operation. The pantograph must maintain good contact under all running conditions. The technical state of current collectors may be described by some parameters and more exactly by ome characteristics. The most important is static characteristic (fig. 4). The springs of the pantograph should assure the constant value of static pressure in operational range. This characteristic may be verified: manually using dynamometer and simple ruler (most

general case), by special measurement arrangement on stationary diagnostics stand with servomechanisms and specialised measurement equipment (time consuming and costly method), and finally on a specially prepared section of overhead line on depot exit track (checking section).

The idea of the last method is presented on fig. 5. In the checking section of the track the overhead line is specially graded in aim to obtain the change of current collector's height. It is necessary to have two distances between supports. In the middle of distance between two catenary masts an additional pole is placed. It enables installation of the sensors for measurement of force or contact wires vertical shift.

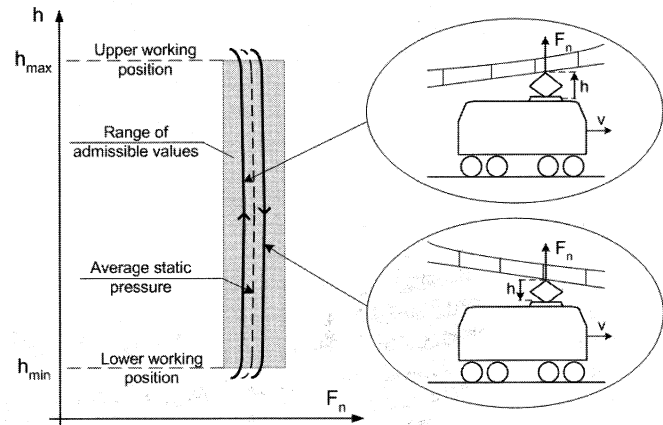

Fig. 4. Static characteristic of the current collector, where h - height of the pantograph, F_n - static vertical force
Rys. 4. Charakterystyka nacisku statycznego odbieraka prądu, gdzie h - wysokość pantografu, F_n - składowa pionowa siły statycznej

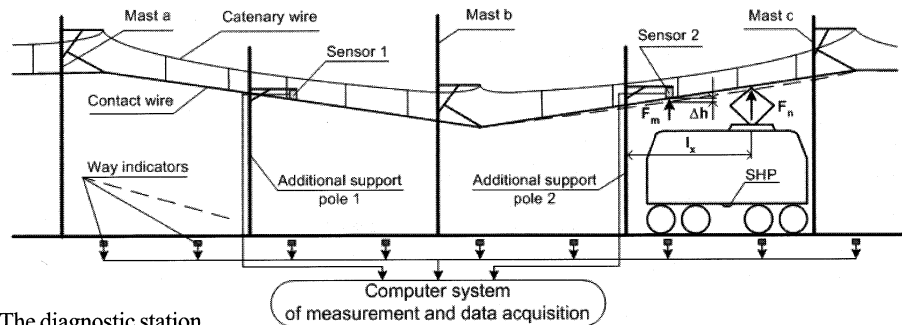

Fig. 5. Idea of the vertical force measurement on checking section
Rys. 5. Koncepcja sieciowego przęsła pomiarowego

Two methods can be applied to for the evaluation of measured results, obtained during the move of the locomotive by the diagnostic section. The first one is the calculation of real vertical force value F_n on basis of the locomotive distance from measuring point l_x and measured force F_m or dislocation of the contact wire Δh (fig. 5). It may be described theoretically (with some simplification) as relation $F_n = f(l_x, F_m)$ or $F_n = f(l_x, \Delta h)$. The distance between the current collector and the measurement pole is obtained on basis of way indicators. The force value should be contained in the admissible range for correctly adjusted pantograph (fig. 4). The idea looks simple, but the problem is the estimation of the real value F_n . Second method depends on evaluation of admissible range values F_m measured by sensors in relation of the distance l_x . (fig. 5). It can be marked on the basis of experiments. In this variant the measured values can be compared with the limit values without estimation of the force F_n .

The measured values should be also analysed in aim of detection of the sudden changes of the force. The large local gradient of curves from fig. 8 indicates bad co-operation of current collector and contact wire.

In practice the mechanical structure of the catenary is rather complicated and it was reasonable to verify this diagnostic concept on physical models. In the Laboratory of Chair of Electric Traction of GUT was built up the complete model of overhead line section, track and current collector on a vehicle in scale about 1:5. The forces were also reduced in given scale and the mean value of vertical static force of collector was 20 N. This model is conformed to one half of scheme presented on fig. 5. It was found that the best results and accuracy gives the sensor of angular force and this solution was chosen [4, 5]. The electric resistance strain gauge was installed as a sensor of the force. The measurement channel consists of amplifier and multi-function computer data acquisition card. To verify the results given by the computer the digital oscilloscope was used. The results of both measurement methods are fully covered. The position of the vehicle is indicated by reed relays located in intervals of 0.5 m, excited by magnet fixed to the vehicle. Software localizes the current collector, measures the actual force and compares it with specified limits. The results are displayed on the screen and recorded on hard disk.

Additionally the possibility of detection of the irregularity wear of the pantograph shoe by similar method was checked out. The wire is staggered in horizontal plane (as in practice) and horizontal force sensors are installed. Irregularity of wear causes the horizontal forces that may be observed as oscillations of the contact wire. The amplitude of oscillations may be a measure of irregularity. Alas till now the simple measurement method of absolute wear value was not found.

Positive results of laboratory experiments have allowed undertaking of the construction of the field-testing equipment in PKP depot in Gdynia. As in laboratory, the half of provided test section was built up. The view of the testing field is shown on fig. 6. The isolated arm joins the contact wire with angular force sensor of force range up to 120 N. So the test may be carried out under full tension of the line. The test section has 48 m length. The locomotive position is

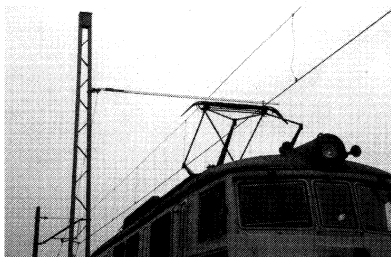

detected by 4 m steps using induction coils excited by electromagnet of braking control system SHP.

Fig. 6. View of the field-testing stand

Rys. 6. Widok pomiarowego odcinka sieci

The relatively high level of disturbances during measurements was observed. It was generated by a pressure of wind, drive of the tested locomotive or others locomotives working on the same line and others. The disturbances have the wide frequency range and are difficult to suppression, especially in low range of about 10 Hz. The oscillogram of force signal presented on fig. 7 was registered during the move of locomotives by test section. The appropriate signal filtration was applied. The remaining disturbances visible on the oscillogram have negligible influence on the measurement accuracy because in the data processing programme the additional digital filtration was implemented.

Series of measurement were carried out and the results were close to the expectations. An example of the results is presented on fig. 8. Limit curves were calculated on the basis of number of results derived from different locomotives, collected during several measuring sessions.

The results of researches are promising. The method is rather simple, measurement equipment is easy to install and so not too costly. The accuracy of range 2 up to 5% obtained during test as well in laboratory as in the field is acceptable. Now the laboratory is preparing the design of such checking section for PKP. The measurement system will be joined with the existing diagnostic stand for the locomotives [3].

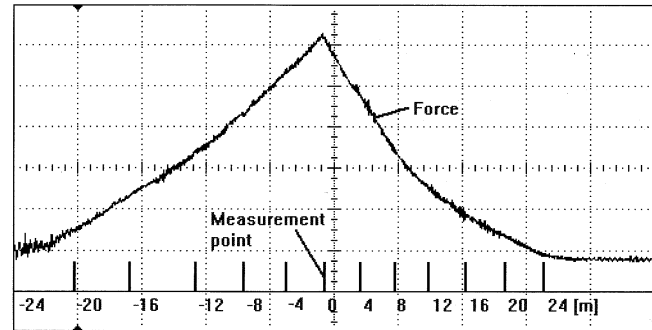

Fig. 7. Waveforms of the force - with included digital filtration of measuring signal (upper line) during testing of the pantograph. The position of current collector every 4 m show the pulses (lower line); vertical scale: 20 N/div, horizontal scale: 10 s/div

Rys. 7. Oscylogram zmiany siły - z włączoną filtracją sygnału pomiarowego (przebieg górny) przy przejeździe lokomotywy. Położenie odbieraka, co 4 m wskazują kolejne impulsy (przebieg dolny). Skala siły - 20 N/dz, skala czasu 10 s/dz

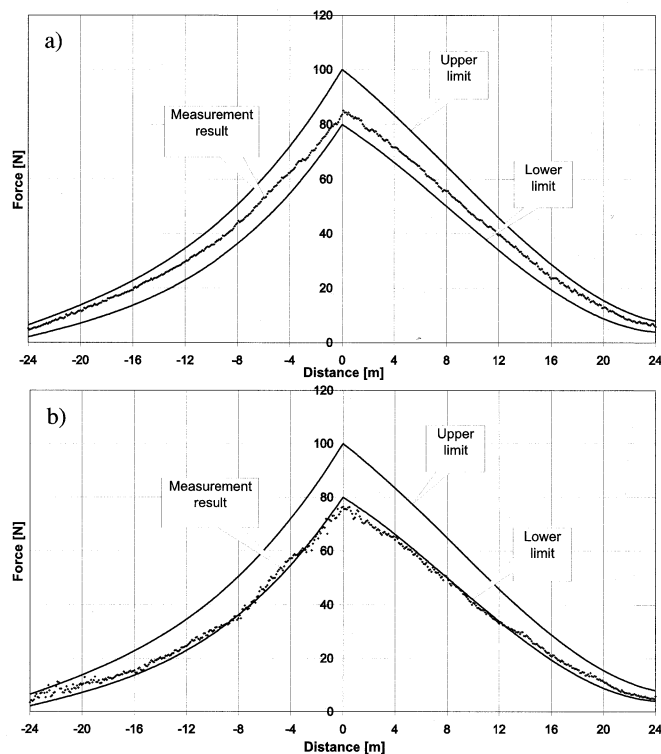

Fig. 8. The exemplary results of measured force in function of position of the current collector on the checking section: a) by correctly adjusted pressure of the current collector; b) by incorrectly adjusted pressure of the current collector

Rys. 8. Przykładowe wyniki pomiaru siły uniesienia w funkcji odległości od czujnika siły przy przejeździe lokomotywy: a) z prawidłowo wyregulowanym naciskiem odbieraka; b) z nieprawidłowo wyregulowanym naciskiem odbieraka

4. Overhead catenary diagnostic system DST

The electric traction overhead catenary plays a special role in the process of traffic maintenance, because its failures often lead to the long-lasting traffic interruption and the costs of repairs are relative high. The majority of foreign railway companies use the modern measurement computer systems for the diagnostics of catenary, mostly installed on the special test carriages [6-9]. The diagnostic process is executed automatically during ride of the carriage on the railway line (so called test run); it includes the measurement of essential parameters of the catenary, as well as the subsequent analysis of the collected results and finally the diagnosis of catenary's technical condition. In 1994 the diagnostic system called DST, controlled by DOS-version software, has been created for PKP; it was installed on two especially adapted carriages [10]. In the next two years several stationary data processing stations were implemented, assigned only for analysis of the collected measurement data. For the third

diagnostic carriage, constructed in 1999, new version of the system called DST++ was applied [11]. In 2001 in one of existing test carriages the newest fully Windows-version of the diagnostic system, DST2000, was introduced. The placement of DST systems currently owned by PKP is presented in fig 9.

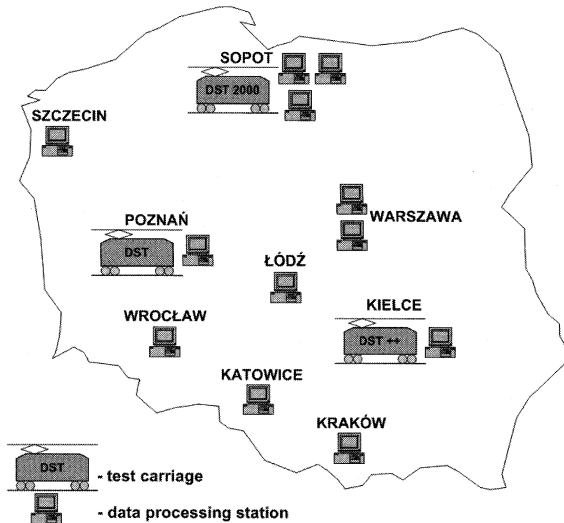

Fig. 9. Placement of DST systems by Polish State Railways
Rys. 9. Potencjał diagnostyczny sieci trakcyjnej PKP

In all versions of DST the following basic tasks are realized: the measurement of contact wire height and deviation (vertical height of line suspension relative to the rails level and horizontal displacement relative to the track axis - so called "zigzag"), detection of hard spots, i.e. strokes of current collector, detection of contact loss between wire and pantograph shoe, control of adjustment of catenary junctions and the measurement of line voltage. Moreover, there are performed: detection of catenary masts (contact wire support points) and inductive coils of braking control system SHP, measurement of carriage distance and speed as well as the registration of the operator's signals. The hard spots are detected using accelerometer installed on the pantograph shoe. For detection of catenary poles, two pairs of ultrasonic transmitters and receivers are mounted on the left and right side of the current collector. The principle of deviation measurement is based on the detection and locating of the contact wire on the pantograph shoe surface. This specially designed shoe consists of two longitudinal parallel contact strips: one of them is solid and the second is transversally sectioned. The contact wire causes the short circuit between the first strip and one of the sectors of the second. This generates the signal in one of the wire detectors connected separately to the sectors of the second contact strip. The excited detector indicates the wire's displacement from pantograph axis - not from the track axis due to the vertical and horizontal carriage pendulous movements, resulting from its elastic suspension on the bogies' frames. For measurement of contact wire height the absolute encoder as a converter of mechanical displacement is used. The value of wire height relative to the tracks is the sum of three different components: the measured height of the wire relative to the roof of the carriage, a fixed value of the carriage height and the dynamic value representing the height of carriage above the track level. The influence of carriage suspension-specific movements on the measured values of height and deviation cannot be neglected, if the geometry of the freely suspended wire, i.e. without pressure from pantograph, is checked. This occurs e.g. by the acceptance procedure of the new built or repaired overhead lines. In this case test run is operated at very small speed and with limited static force of current collector. For measurement of the carriage-box pendulous movements the incremental encoders with self-coiled line fixed between the carriage frame and axle box were implemented. This measurement, along with the values of current collector static force and overhead line

elasticity introduced into the programme by the operator, allow the software correction of measured height and deviation values.

The measurement of all parameters is performed under control of programme MEASUREMENTS during the test run. The data are recorded related to distance with 1-meter resolution. The software analysis of contact wire deviation allows the additional analytical detection and locating of support points. Due to the high density of data and the use of flip-flops in contact wire detectors, that limits the effects of momentary loss of contact between the wire and the pantograph shoe, this analytical method shows good reliability.

The essential part of the DST 2000 is the video-diagnostic subsystem. The video signal from the camera, installed in the special turret on the carriage roof and directed on the pantograph shoe, is overlaid with the VGA signal from computer, containing: special scaling grid, selected measurement results and identification data. The joint signal is recorded by the VCR and displayed on the TV-set. The image of continuous co-operation between contact wire and pantograph shoe, shown on the background of scaling grid, enables the visual evaluation of height and deviation of line suspension. This evaluation may be supported by the selected measurement data displayed in the text form in screen corners. The visual part of diagnosis process, although time-consuming and subjective, allows noticing the non-measurable failures of the tested overhead line.

The hardware structure of the diagnostic system and the location of measurement equipment in the test carriage are shown in fig. 10.

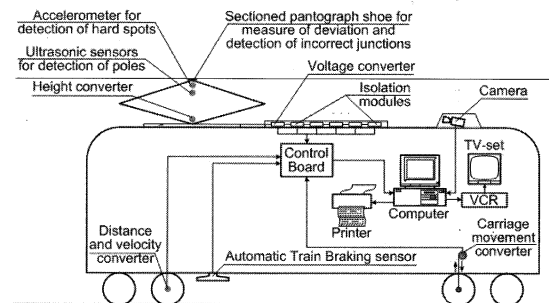

Fig. 10. Architecture of overhead catenary diagnostic system DST2000
Rys. 10. Architektura systemu diagnostycznego DST2000

The central part of data processing station is the industrial version of PC/Pentium microcomputer. The coupling between the computer and selected measurement sensors, power supply relays and video-equipment is realised by typical I/O-cards. Specialised modules, designed and made as prototype, are necessary due to the non-typical voltage level of some sensor output signals. Most of cards and modules have optically isolated inputs because the computer should be electrically separated from signal sources and very long transmission cables by the safety and EMC reasons.

After finish of the measurement process, the recorded data are analysed to evaluate the technical condition of the tested catenary; this is executed by the use of the programme RESULTS. The collected data are also the source values for creating the specific so called location-database for the tested railway line; this may be done by the use of the programme BASE.

The correct locating of the catenary masts is substantial for the evaluation of measured and calculated results, because the nominal values of some parameters, as e.g. the deviation or height gradient, are defined only for the support points. The worldwide-applied methods for its detection do not feature 100-percent efficiency. The optical systems are the most promising [6-8]. They are based on real-time analysis of the images from several cameras, but are very expensive and are being mostly in research phase. The efficiency of the supersonic sensors, used in the DST system, was evaluated on the basis of large number of experiments. It is contained in the range from about 85% - by speed of 160 km/h up to 100% by the quasi-static measurements i.e. by speed below 40 km/h. The implemented analytical detecting algorithm increases the detection reliability.

Nevertheless the user should sometimes correct the final locations of the support points, given by the programme. These are time-consuming operations, because the continuous comparison of the VCR-recorded image of catenary line with the results generated by the computer is required. To obtain the maximum of automatism and objectivity of diagnostic process, the data processing algorithm uses the specially created database, which includes all essential data defining the precise locations of catenary elements. The programme BASE, assigned for creating and edition of the base-files, is the essential part of the system software. The base-files are created progressively on the basis of measurement data taken from test carriage after its first diagnostic run on given railway line. Also the technical data contained in the documentation of catenary and the set of diagnostic criteria contained in the maintenance instructions and normalisation standards are taken into account. The base-file contains the verified structural and location data (the location and designation of support poles, the track curvature, location of catenary junctions and areas of wire tensioning), as well as the diagnostic criteria specific for each catenary section. These files may be updated at any time. The process of creation and use of the location-database is shown in fig. 11.

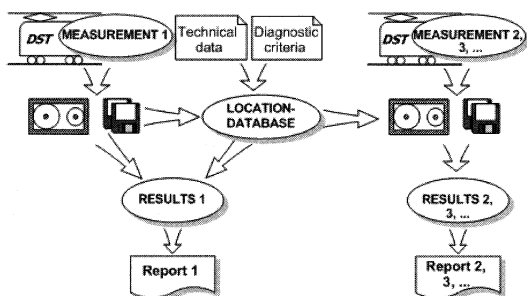

Fig. 11. The creation and use of the location-database in the diagnostic process
Rys. 11. Proces przetwarzania danych w systemie diagnostycznym

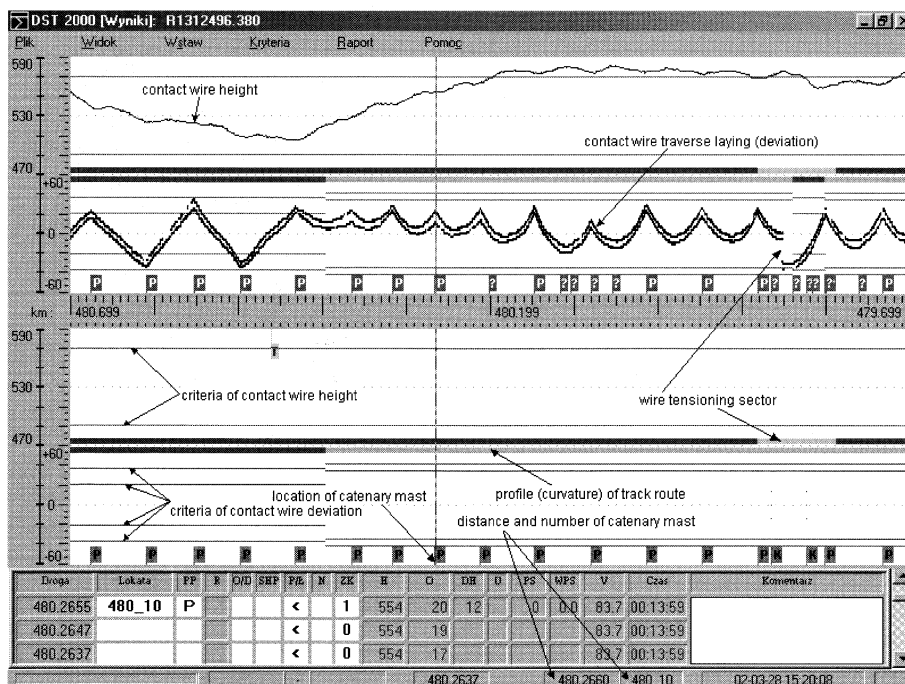

Fig. 12. Print screen of the programme RESULTS after partial coordination of measurement data (up) and location data (down); descriptions of image symbols were added

Rys. 12. Widok ekranu w programie WYNIKI po częściowej synchronizacji danych pomiarowych (okno górne) i lokalizacyjnych (okno dolne); na rysunku dodatkowo naniesiono opis symboli graficznych

In the programme RESULTS the process of coordination of lately measured data with existing base-file of the same catenary sector

take place. During its execution the main location-data and locally valid diagnostic criteria are transferred into the respective records of the results-file; moreover they are taken into account by the estimation of catenary's technical condition. This process runs automatically until the disagreement occur - in defined band of tolerance - between location of real support point (contained in database) and the point detected by ultrasonic sensors or by analytical method. By such disagreement, the programme demands from the user the indication of the real place of the catenary's mast (e.g. by support of the videotape or technical documentation), and then continues the coordination again. The example of the use of the base-file is presented in fig. 12. The upper graphic window of the screen contains the diagrams of the new measured parameters of catenary. The data in the bottom graphic window of the screen are taken from the base-file. In the example the coordination of both files was executed from the left side up to the vertical line-marker in the middle of the screen. In the upper window right from the marker a number of possibly false detections or locating of support points are visible, as well as the area of incorrect indication of track profile and false criteria for contact wire deviation. In the upper graphic window are also visible the curve of contact wire height and the trails of the wire detection on pantograph shoe, which allow the evaluation of the deviation. Similar looking diagrams, as well as the textual diagnostic reports in chosen form, may be also printed.

The entire software of system DST2000, including the real-time measurement procedures, was created for Windows in C++ language, only the drivers for I/O-cards have been written in assembler. The experiments in laboratory proved, that the system work properly without loss of data records up to carriage speed of about 600 km/h.

References

- [1] E. Jergas: Fortschrittliche Fahrzeugunterhaltung durch den Einsatz von Diagnoseanlagen. Elektrische Bahnen 1976, nr 5.
- [2] J. Niewiadomski, P. Pazdro: Wagon pomiarowy do badań kolejowej sieci trakcyjnej. Traction i wagony 1978, nr 2.
- [3] P. Pazdro: Technische Diagnostik für Steuerstromkreise elektrischer Lokomotiven. ZEV Glas. Ann. 1982, nr 2/3.
- [4] P. Pazdro, K. Karwowski: Operational technical diagnostics of current collectors. ZEV+DET Glas. Ann. 2001, nr 9/10.
- [5] P. Pazdro, K. Karwowski, M. Mizan: Diagnostyka ruchowa odbieraków prądu. Technika Transportu Szynowego 2002, nr 7-8.
- [6] J.M. Van Gigh, C. Smorenburg, A.W. Benschop: The contact wire thickness - measuring system (ATON) of the Netherlands Railways. Rail International 1991, No. 4.
- [7] N. Dimopoulos, H. Höfler, H. Wölfelschneider: Erkennen von Oberleitungsstützpunkten und -masten mit Lasertechnik. Elektrische Bahnen 2000, Nr. 1-2.
- [8] U. Richter, R. Schneider: Automatische optische Inspektion von Oberleitungen. Elektrische Bahnen 2001, No 1-2.
- [9] B. Sarnes: Inspektion von Fahrdrathlage und -stärke bei beliebiger Geschwindigkeit. Elektrische Bahnen 2001, No 12.
- [10] Z. Giętkowski, K. Karwowski, M. Mizan: Nowa generacja systemu diagnostycznego sieci trakcyjnej - DST. Technika Transportu Szynowego 1995, nr 6/7.
- [11] Z. Giętkowski: Identyfikacja danych pomiarowych w diagnostyce sieci jezdnej. 5th Int. Scientific Conf. Modern Electric Traction in Regional and Urban Transport MET'2001, May 31 - June 02, 2001, Gdańsk.

Tytuł: Badania i wdrożenia w zakresie diagnostyki technicznej w trakcji elektrycznej

Artykuł recenzowany